

F · S · T
FINE SCIENCE TOOLS



50
FINE
YEARS

FINE SURGICAL INSTRUMENTS FOR RESEARCH™

ORDERING INFORMATION



TELEPHONE

+1 800-521-2109 or +1 650-349-1636
Mon.-Fri. 8:00 am to 5:00 pm
Pacific Time



FAX

+1 800-523-2109 or +1 650-349-3729



MAIL

Fine Science Tools (USA) Inc.
4000 East 3rd Avenue, Suite 100
Foster City, CA 94404-4824



ORDER ONLINE

finescience.com



EMAIL-CUSTOMER SERVICE

america@finescience.com

EMAIL-ORDERS

orders-us@finescience.com

For a complete explanation of our returns and exchange policies, please refer to our website.

CHECK OUT OUR NEW WEBSHOP

finescience.com

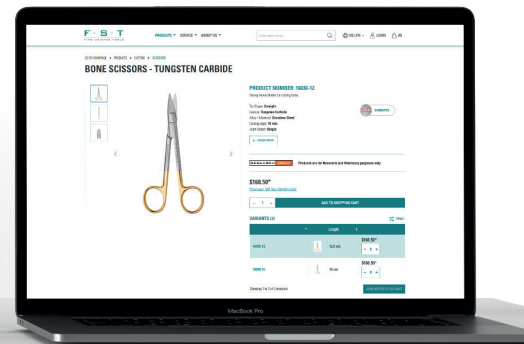
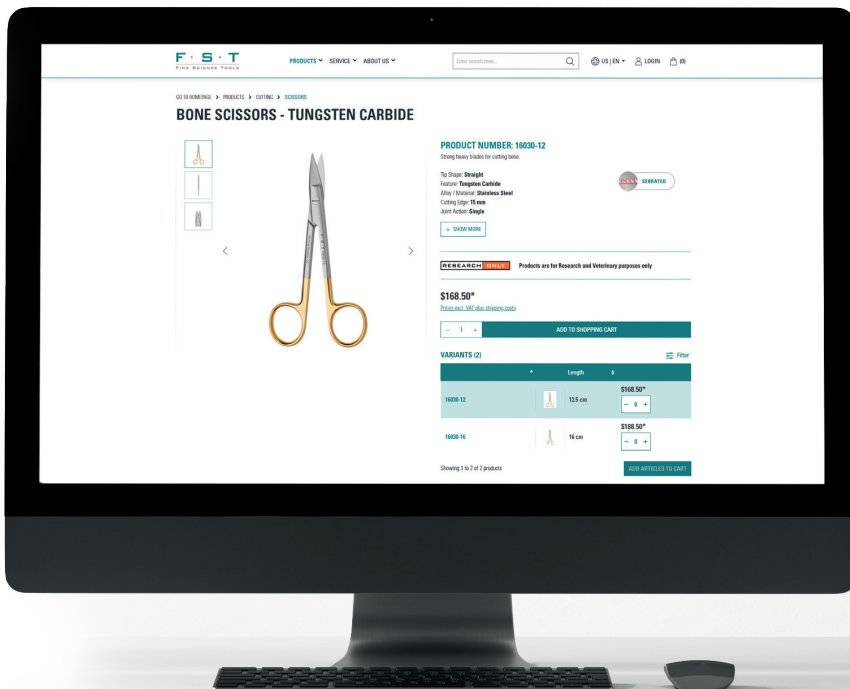



LETTER FROM THE OWNER

Markus Gawenda
Owner

Dear Valued Customers, Partners, and Friends,

As I reflect on this milestone moment, I am filled with profound gratitude and a deep sense of emotion. 50 Fine Years ago, our journey began with a vision from my uncle Hans - a vision that has evolved into the vibrant tapestry of experiences, relationships, and achievements that define our company today.

Our story is not just one of business success, but of lasting partnerships forged in trust and mutual respect. It is a narrative woven with the threads of perseverance through challenges, innovation in the face of change, and above all, a commitment to quality and excellence in everything we do. We understand the critical importance of each instrument that bears our name, knowing that behind every tool lies an important mission relying on the knowledge, skill and dedication of our end users. This awareness drives us to maintain the highest standards of craftsmanship, sophistication, and reliability in our instruments.

To our loyal customers, your unwavering support and feedback have been the cornerstone of our growth. You have entrusted us with your needs, and it has been our privilege to serve you. Each interaction and request have been an opportunity for us to learn, to improve, and to strive for continuous evolution. We are thrilled to celebrate our company's birthday, and in this special moment, we want to extend our heartfelt gratitude. To show our appreciation for your support, we are introducing our Golden Ticket, where you will have the chance to win exciting prizes as our way of saying thank you for being a part of our story.

To our dedicated partners, your collaboration has been instrumental in our journey. Together, we have navigated uncharted waters, adapted to shifting landscapes, and embraced new horizons. Your expertise and commitment have helped us reach milestones we once only dreamed of.

To our incredible team spanning across the globe, past and present, you are the heart and soul of Fine Science Tools. Your hard work, dedication, and passion have been the driving force behind our success. Through your creativity and determination, you have turned challenges into opportunities and brought aspirations to life.

In commemoration and tribute to our Founder Hans Gawenda, we are delighted to introduce the Bonn-Gawenda Scissors - a testament to our revolutionary capabilities encompassing state of the art features, fabricated with utmost sophistication. These limited-edition scissors celebrate our heritage of ingenuity and the astounding legacy Hans has left behind.

As we celebrate this 50th anniversary, we honor not only our past but also look forward to an exciting future. We are excited to announce the opening of FST Asia in Hong Kong, China, as we continue to diversify and enhance how we serve our customers across the globe. The world around us may change, but our commitment to delivering high quality instruments, vast selection, and unparalleled service remains steadfast.

To everyone who has been a part of our journey - thank you. Your belief and patronage in us have been our greatest asset. As we continue to write the next chapter of our story, we do so with optimism, humility, and a renewed sense of purpose.

Here's to the next 50 years of learning, innovation, growth, and shared success.

Warmest regards,
Markus Gawenda

Timeline

FST SINCE 1974

For 50 years, Fine Science Tools has been the leading distributor of precision surgical and microsurgical instruments, as well as laboratory accessories with offices in Forster City (USA), Heidelberg (Germany) and Hong Kong (China) supporting and serving customers across the globe.

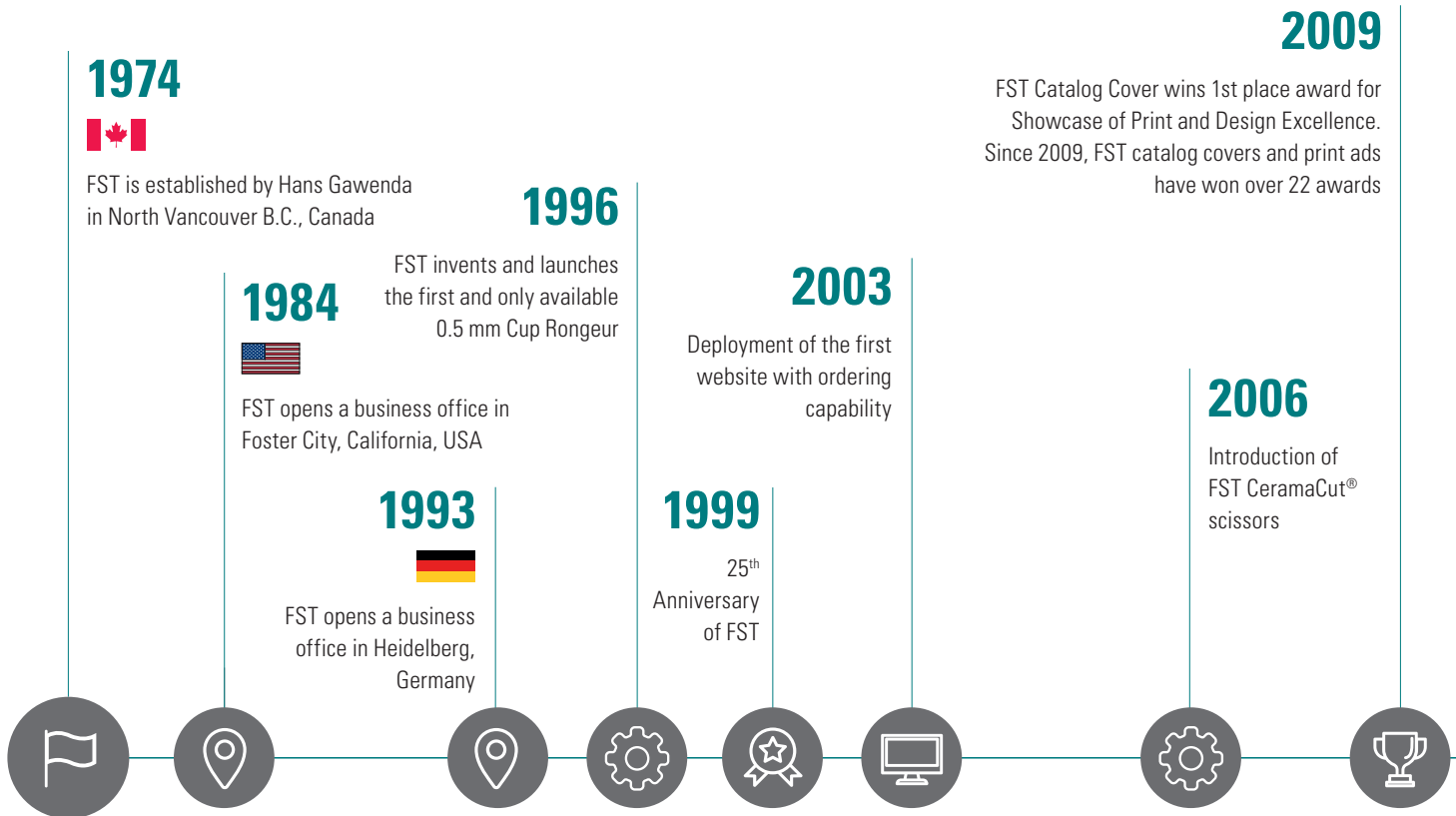

2024

50th Anniversary of FST



FST opens a business office in Hong Kong, China



Launch of our FST "Exclusive Line"



New Webshop Launch



2019

Markus Gawenda joins the company

US Office moves and expands in Foster City, California, USA



2023

Markus Gawenda becomes the sole owner

2021

FST establishes a global Management-Team

2014

FST wins the Highest Attention-Getting Ads in Magazines

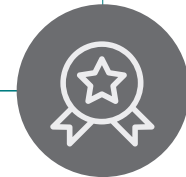

Exclusive Line

BONN-GAWENDA SCISSORS

To celebrate our 50th anniversary, we're proud to introduce the Exclusive Line, meticulously crafted to support every aspect of your research needs. At the heart of this collection is the Bonn-Gawenda Scissors, created as a tribute to our founder, Hans Gawenda, and symbolizing our legacy of innovation and excellence. These scissors stand out for their advanced design and exceptional craftsmanship, reflecting the high standards that have always defined our work.

The ToughCut® technology incorporates one micro-serrated cutting edge paired with a razor-sharp blade, delivering consistently clean and precise cuts. These scissors have perfect tips for precision work under a microscope. Designed with comfort and ergonomics in mind, the large finger loops and specially engineered handle ensure exceptional control throughout each use.

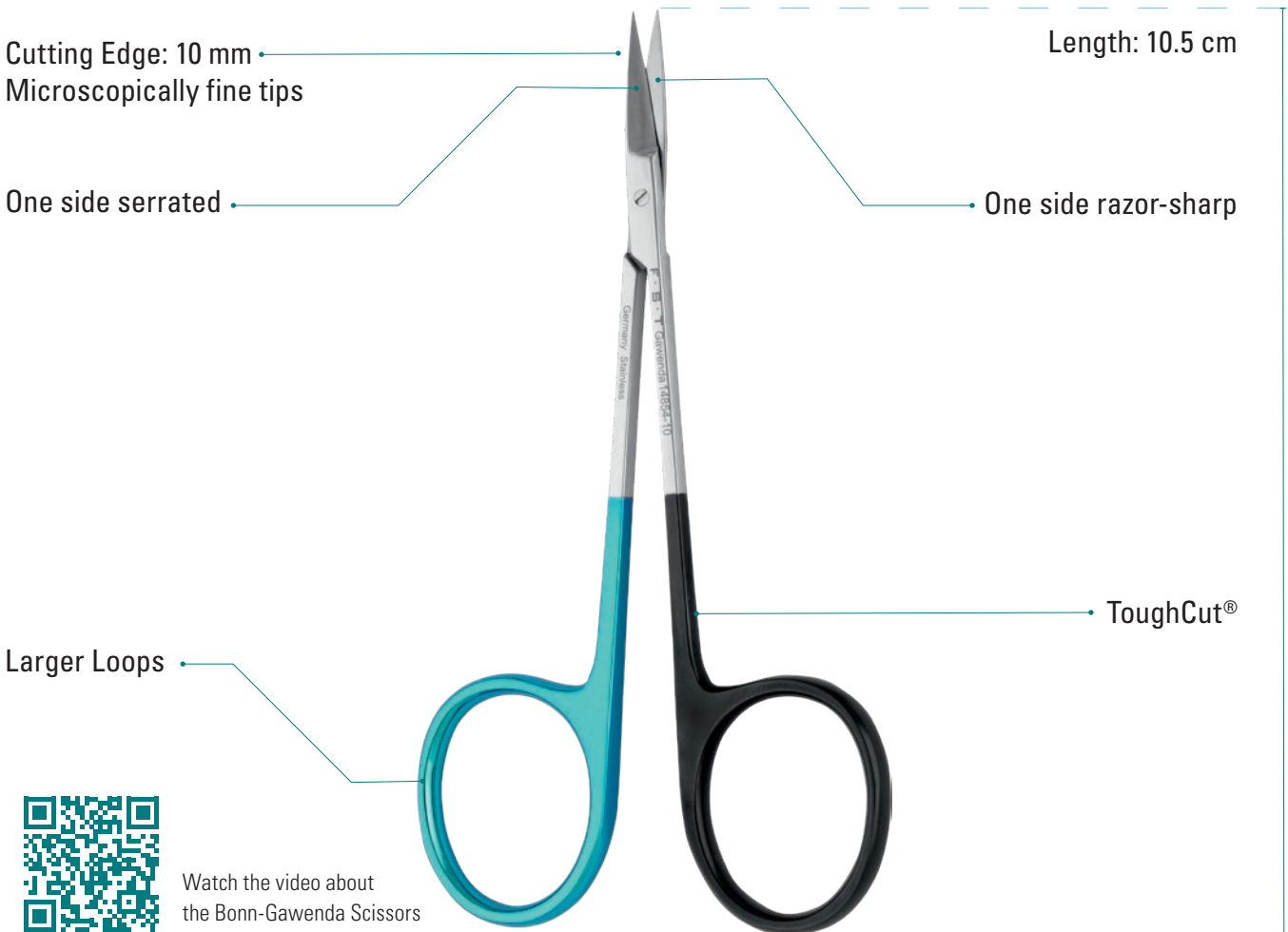

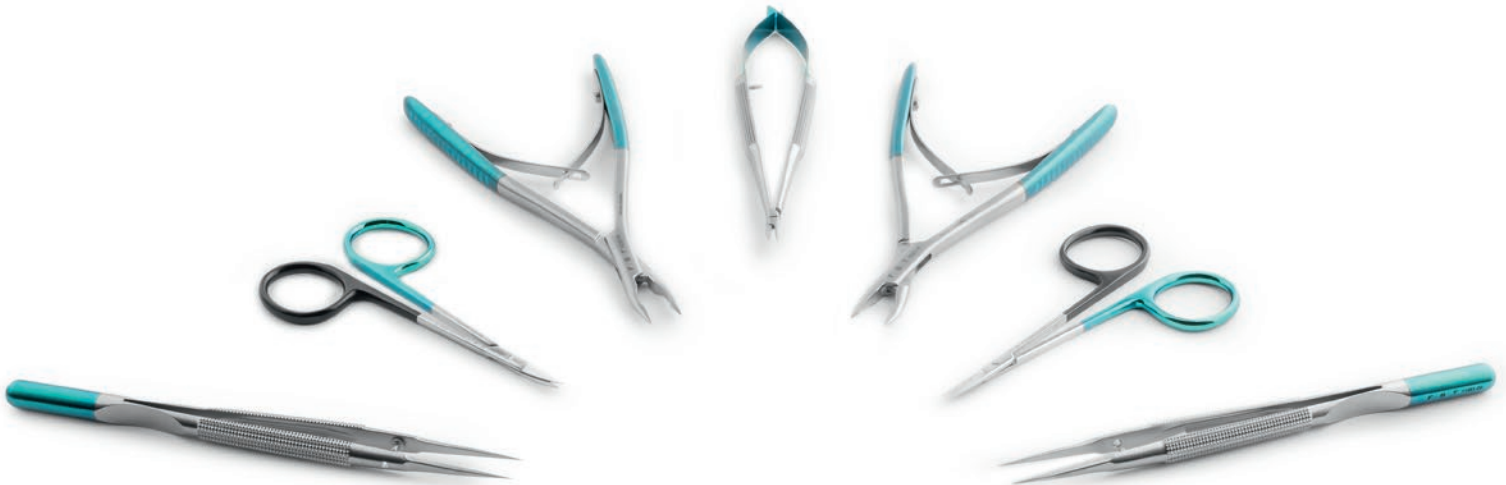

F · S · T

Exclusive Line

Introducing our Exclusive Line which offers a unique combination of popular features from our tools combined into one. Whether you're seeking elegance, stability and ergonomics, or versatile functionality, the Exclusive Line was specially designed to cater to every aspect of your research needs.



Look for the Exclusive Line icon in the catalog.



14854-10

14855-10

16220-14

16221-14

12875-13

11851-20

11852-20

TABLE OF CONTENTS | CATALOG 2025

Letter from the Owner	1
Timeline	2 – 3
Exclusive Line	4 – 5
Table of Contents	6 – 7
Catalog Features	8 – 9
Handcrafted	10 – 11
Custom Design	10
Scissors Test	11
Satisfaction Guarantee	12 – 13
Quality Control	12
Repair Service	13
Alloys & Materials	14 – 15
Maintenance & Care	16 – 19

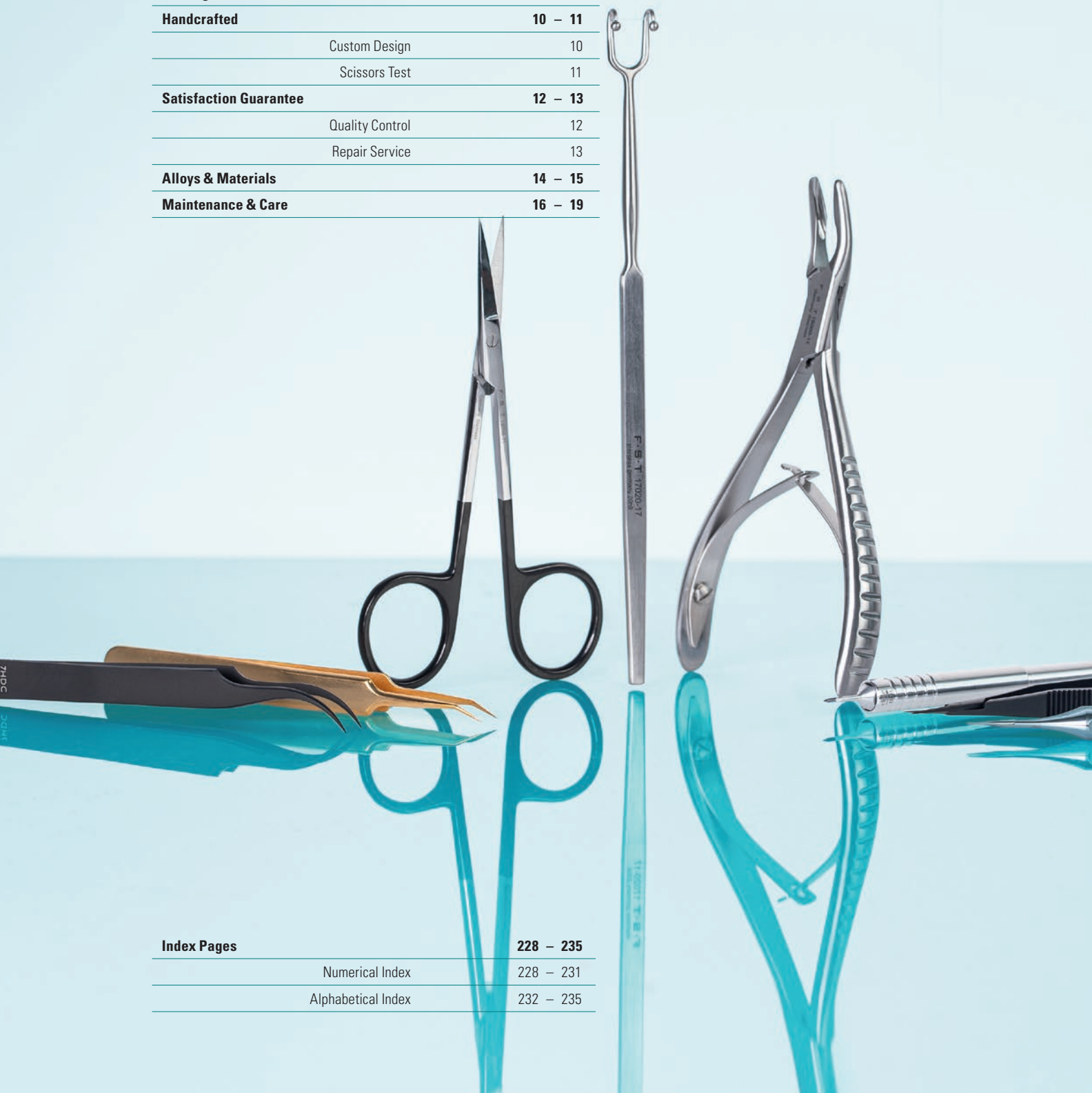

Index Pages	228 – 235
Numerical Index	228 – 231
Alphabetical Index	232 – 235

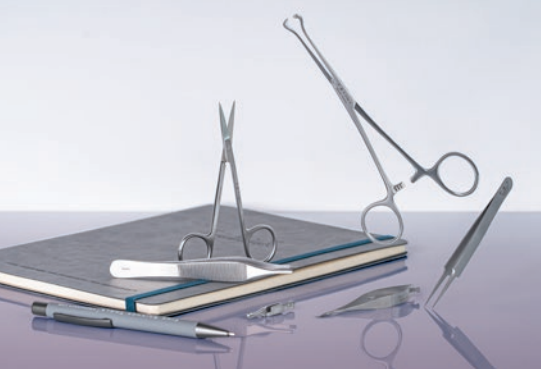

Scissors	21 – 54
Spring	21 – 33
Fine	34 – 47
Surgical	48 – 54
Bone Instruments	55 – 69
Rongeurs	55 – 59
Cutters	60 – 66
Accessories	67 – 68
Curettes & Chisels	69
Knives & Scalpels	70 – 81

Forceps/Tweezers	83 – 116
FST by Dumont	83 – 92
Fine	93 – 96, 100 – 104
Moria	97 – 98
S&T	99
Standard	105 – 116
Hemostats	117 – 122
Vascular Instruments	123 – 133
Clamps	123 – 127
Occluders & Ligation	128 – 130
Dilation & Cannulation	131 – 133

Probes & Hooks	135 – 139
Spatulae	140 – 144
Spoons	145
Pins & Holders	146 – 147
Wound Closure	148 – 159
Needle Holders & Suture	148 – 156
Staplers, Clips & Applicators	157 – 159
Retractors	160 – 167

Animal Accessories	169 – 174
Feeding Needles	169 – 170
Animal Identification	171 – 174
Instrument Care & Accessories	175 – 186
Instrument Care	175 – 176, 184 – 186
Sterilization & Storage	177 – 183
Surgical Accessories	187 – 190
Drill Accessories	187
Cauterizers	188 – 189
Laboratory Accessories	191 – 203
Tools	191 – 196
Magnifiers & Lens Paper	197 – 203

Student Quality Instruments	205 – 227
Quality instruments with the student in mind	
Scissors	206 – 211
Cutter	211
Scalpel Handles	212
Forceps	213 – 218
Hemostats & Towel Clamps	219 – 225
Pin & Needle Holders	226
Retractors, Vessel Dilator & Clamps	227

Catalog Features

PRODUCT FEATURES

To provide you with our support regarding your decisions in finding the right instruments for your purpose, the product feature details are explained below.

Most Items in the catalog are shown in actual size.

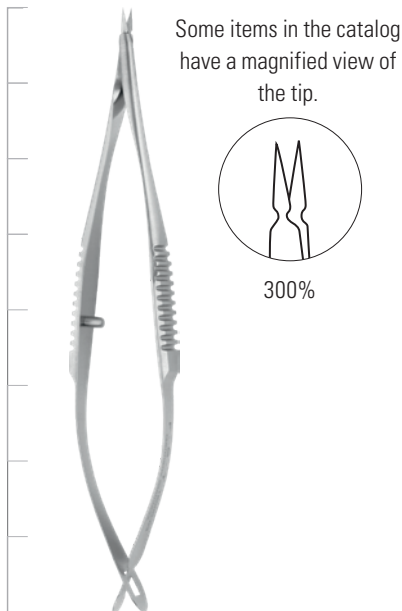

Some items in the catalog have a magnified view of the tip.

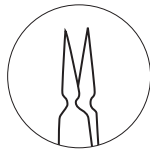

300%



Most items in the catalog have an illustrated view of the tip.

Straight Sharp/Sharp

Length: 8 cm
Cutting edge: 2 mm
Tip Ø: 0.05 mm

No. 15000-03

Detailed item specifications.

ICONS



The Exclusive Line offers a unique combination of popular features of our tools combined into one. Whether you're seeking elegance, stability and ergonomics, or versatile functionality, the Exclusive Line is specially designed to cater to every facet of your research needs.



Fine Science Tools has noted which items are most frequently purchased for use in a variety of surgical procedures. To find our most popular items, look for the "most popular" icon throughout the catalog.



Our yearly selection of new instruments is based on a careful study and knowledge of our customer needs, as well as listening to their requests.



These items are not suitable to autoclave, but can be sterilized by a different method. For example: hot bead sterilization, gas sterilization, plasma sterilization or hot air sterilization. Please contact us to receive more information regarding the best preferred method for your instruments.



Fine Science Tools is proud to offer a large selection of left-handed surgical instruments to the research community. To find our left-handed instruments in this catalog, look for the "left-handed" icon on the pages below.

Scissors: pages 37, 48
Hemostatic Forceps: page 118
Needle Holders: pages 152 - 153
Ligation Aid: page 131



FST features a selection of scissors with larger than normal finger loops. Most of these loops are easily adjustable to fit larger fingers more comfortably. To find our large loop scissors please look for the "large loop" icon on the pages below.

Scissors: pages 34, 38, 47 and 50



The tips have micro serrations to ensure a better grip on tissue or other materials.

WE PROUDLY STOCK

F · S · T
by DUMONT

Fine Science Tools offers a wide selection of the latest and most popular Dumont forceps. Handcrafted in Switzerland for more than a century, these forceps are known for their consistent and uncompromised fineness.

Dumont forceps come in an array of styles and alloys. Below you will find detailed descriptions to help guide you in choosing the right Dumont forceps best suited for your needs.

FINDING THE DUMONT FORCEPS BEST SUITED FOR YOUR NEEDS

Alloys	Hardness	Magnetic	Temperature resistance	Autoclavable	Advantages
Titanium	Least Hard	No	Up to 430 °C	Yes	Resistant to corrosion from nitric acid, chloride, and salt water. Titanium is 40% lighter than stainless steel.
Dumoxel	Hard	No	400 °C	Yes	The most popular alloy available for Dumont forceps offers the best resistance to corrosion, sulphuric environments, hydrochloric acids, and all other mineral and organic acids.
Inox	Harder	Yes	400 °C	Yes	Available for most Dumont forceps. Contains chromium added to carbon steel, which results in some loss of hardness but offers good stainless qualities and resistance to corrosion.
Dumostar	Harder	No	500 °C	Yes	More durable and corrosion resistant than the best stainless steels. Highly resistant to mineral and organic acids, and salt water. Dumostar lasts an average of four times longer than Dumoxel and Inox. Most cost effective alloy for laboratory use.
Carbon	Hardest	Yes	N/A	No	Extremely hard; ensuring strong tips. Easily stains and rusts without proper care. Carbon cannot be immersed in a water bath or sterilized.

Tip profiles: Dimensions vary. See each style for specific dimensions (width x thickness).

Standard	Made for high precision and consistently precise work under a microscope.
Biology	Twice as fine as "Standard Tips". Especially produced for high precision laboratory work under the microscope.
Super Fine Tips	Four times finer than the "Standard Tips". These tips are extremely delicate for the finest work under the microscope. Extra care is needed for these tips as they are very fragile.

Styles

#2	Straight forceps with wide yet fine tips, referred to as Mouse Laminectomy Forceps because of their popularity in breaking off delicate bone from mouse skulls.	#5XL	Extra Long #5 forceps.
#2AP	Epoxy coated with flat wide blunt tips.	#5/45	Tips angled at 45°.
#3	Long straight forceps with coarse tips. Popular in low magnification procedures.	#5/45C	Designed to pick up cover slips from multi-well plates.
#3C	Shorter version of #3.	#5/90	Tips angled at 90°.
#4	Similar to the #5 but with broader shanks and stronger tips.	#5AC	Self-closing Anti-Capillary forceps.
#5	Most popular style of Dumont straight forceps with fine tips which come in several styles.	#6	Sharply angled, broad tips.
#55	Similar to the #5 but with lighter shanks, giving the forceps a lighter spring action.	#7	Most popular style of Dumont curved forceps with fine tips which come in several styles.
#5CO	Similar to the #55 but with even finer shanks producing the lightest spring action and longest meeting surface of any Dumont style.	#7B	Curved serrated tips.
#5L	Medical #5 forceps with slide sleeve for a secure hold and retention.	AA	Strong broad tips.
#5SF	The finest tips ever produced by Dumont.	M	Mini forceps.
		Medical	Denotes distinctive ribbed handle to maximize grip.
		SS	Long and narrow shanks with thin tips.
		WA	One piece design with no soldering grooves allows the forceps to be thoroughly and easily cleaned preventing biofilm residue.

Handcrafted



PRECISION THAT MAKES A MARK

Our highly skilled and experienced surgical mechanics refine and perfect our instruments in FST's very own workshop, a step that only we take in this manner. This is crucial for the precision and consistent quality of our products. For example, our Friedmann-Pearson rongeurs with a tip diameter of 0.5 or 0.7 mm are unique in the world. Our spring

scissors have also established themselves in the research industry and are unsurpassed in their fineness. The result: a level of quality to be proud of - and to which we have now committed ourselves to. Our "Handcrafted" symbol stands for 100% guaranteed craftsmanship and instruments that you can rely on today, tomorrow, and always.



CUSTOM DESIGN

Have you ever thought about how wonderful it would be to have a personalized, unique instrument perfect for your needs? Please contact us to learn about our custom capabilities to manufacture any instrument to

your specific specifications and requirements. We as well have the capability to perform special modifications to our existing instruments.



SCISSORS TEST

Does paying more for a pair of scissors really buy more value and a longer cutting life?

The picture below shows our cutting test for ring scissors based on the standards and specifications of surgical instruments in our office in Heidelberg. Each pair of scissors must perform a smooth cut without tearing or fraying the material, specifically at the fine tips. In addition, a specialized long-term test is done to identify the longevity of other featured alloys and cutting edges, Tungsten Carbide and ToughCut®. In this test the scissors will repeatedly cut through a continuous feed of cotton cloth and a counter keeps track of the number of cuts made

to evaluate when the scissors begin to show a decrease in cutting quality.

The results showcase the addition of added features dramatically increases the cutting life of the scissors. Most notably, the cutting life is more than doubled with the addition of ToughCut® blades and over six times longer with our CeramaCut® feature.

See the chart below for a comparison of four different scissors sold by FST.



The cutting life is more than doubled with the addition of **ToughCut®** blades to stainless steel, and over six times longer with **CeramaCut®** blades.

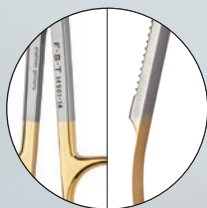

Tungsten Carbide®
Lasts longer than stainless steel by: **1.9x**

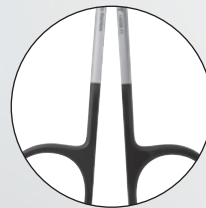

Stainless Steel with ToughCut®
Lasts longer than stainless steel by: **2.3x**



Tungsten Carbide with ToughCut®
Lasts longer than stainless steel by: **4.1x**



CeramaCut® (Ceramic Coated Tungsten Carbide with ToughCut®)
Lasts longer than stainless steel by: **6.6x**

Satisfaction Guarantee

QUALITY CONTROL

The high quality of Fine Science Tools surgical and microsurgical instruments is the result of our relentless attention to detail. Almost every instrument we sell is manufactured by skilled European craftsmen, designed to exacting specifications made from the finest German stainless steel alloys, and forged from the strongest, lightest materials available, and tested to ensure precision performance and ergonomics.

We are dedicated to quality control, with technicians in our German office inspecting most

FST instruments. Aside from checking instrument dimensions and specifications, we thoroughly inspect tip sharpness, cutting edges, springs, joints, and other various components. Only after passing our detailed inspections, instruments are approved and sealed with our "FST Inspected" sticker.

We are proud to back all of our products with a 100% satisfaction guarantee. If, for any reason, you are not completely satisfied with your purchase, you may return it for a full refund.

100% SATISFACTION GUARANTEE

"If, for any reason, you are not completely satisfied with your purchase, you may return it for a full refund."

Hans Gawenda, Founder, Fine Science Tools Inc.

F · S · T
FINE SCIENCE TOOLS

FINE SCIENCE TOOLS SERVICE

We are constantly trying to improve ourselves and our service. Our service includes the preparation and repair of instruments, custom-made products and individual pieces of various instruments according to customer requirements, customer-specific advice based on their application and more.

Over the years we have built up a network of partners and collaborations with well-known institutions and companies. As a result, we also offer application-specific instrument kits including complementary items from our partners.

If you are interested or have any questions, please give us a call at one of our offices.



REPAIR SERVICE

In our very own workshop in Heidelberg, Germany we not only manufacture and customize specific instruments according to customer requirements, but also offer a repair service for all of our products.

Which includes:

- General repairs
- Sharpening of scissors/spring scissors
- Adjustments of forceps
- Replacement of Tungsten Carbide jaws
- Cleaning & reconditioning
- Replacement, if an instrument is beyond repair

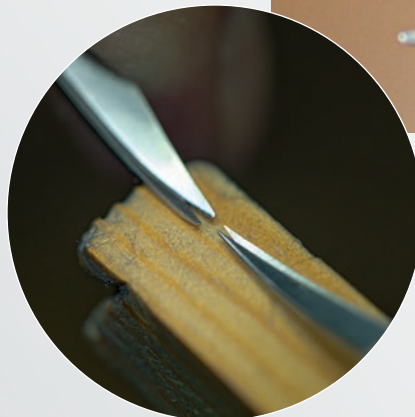

Additionally, our team is also available for repairs of your instruments which have not been purchased from FST.

Alloys & Materials

There are various alloys and materials which are used to produce micro surgical instruments for research with each having certain properties that would be advantageous in particular environments or applications.

We will introduce these alloys, describe their benefits and highlight unique tools for particular procedures that may be ergonomic and overall helpful for your studies and/or protocols.



ToughCut® Scissors

- Black handles
- Last approx. 2.3x longer than stainless steel
- One cutting edge has micro serrations to minimize tissue slippage
- One cutting edge has increased sharpness (cutting edge with a 30° instead of 15° angle)



Tungsten Carbide Instruments

- Golden handles (short gold plating)
- Last approx. 1.9x longer than stainless steel
- Is welded onto the cutting edges of scissors tips of forceps and needles holders
- Available instruments: bone cutters, scissors, forceps, needles, needle holders, burrs

Stainless Steel Instruments

Stainless steel is an alloy, which does exactly what its name implies: stains less than ordinary steel (iron).

- Autoclavable





CeramaCut® Scissors

- Golden handles and black coating
- Last approx. 6.6x longer than stainless steel
- Cutting edges with Tungsten Carbide and ToughCut® plus ceramic coating
- Tungsten Carbide is one of the hardest materials on earth
- Reduced glare



Tungsten Carbide & ToughCut® Scissors

- Golden handles (long gold plating)
- Last approx. 4.1x longer than stainless steel
- One cutting edge has micro serrations to minimize tissue slippage
- One cutting edge has increased sharpness (cutting edge with a 30° instead of 15° angle)



Titanium Instruments

- Approx. 40% lighter than stainless steel
- Softer alloy than stainless steel
- Corrosion resistance (cannot rust)
- Non-Magnetic
- High temperature resistance up to 440 °C / 824 °F
- Available instruments: scissors, forceps, probes, hooks, spatula, vascular clamps



Ceramic Instruments

- Ceramic coating
- Last approx. 2.3x longer than stainless steel
- Reduced glare
- Available instruments: Dumont forceps, spring scissors



Learn more about our Alloys & Materials



Maintenance & Care

Proper care of your surgical instruments will improve their longevity and function. Below are different cleaning, sterilization, and maintenance processes to guide you through your techniques.

GENERAL

Guidelines to extend the life of your surgical instruments.

Clean and thoroughly dry your instruments as soon as possible after each use, paying special attention to joints, hinges, and anywhere there is metal to metal contact.

Handle your instruments delicately and with care.

Use your instruments for their intended purpose.

Store your instruments with tip protectors, and always place them so that they do not touch each other.



CLEANING

Fine surgical instruments should be cleaned immediately after use. Blood or saline solutions left on instruments for any length of time can quickly start corrosive action. Time, temperature, and agitation play important roles in the cleaning process. Time affects the efficiency of cleaning solutions as most are effective after a certain time period. Higher temperature cleaning solutions result in better cleaning. During manual or ultrasonic cleaning it is helpful to loosen any surgical residue. Before any of the below procedures, rinse your instruments under warm running water to remove all blood and tissue. Instruments can be cleaned manually or ultrasonically, but always:

Use a neutral pH (pH7) cleaning solution.

Clean instruments in the open position to ensure a thorough and effective cleaning process.

Use soft textile or paper cloths, soft plastic brushes made of nylon, or water spray guns.

Do NOT use steel wool, wire brushes, or scouring pads as these are abrasive to the instruments.



MANUAL CLEANING

- ⚠ Make sure all instruments are visibly clean and free from stains, wiping them carefully to remove all blood and tissue matter.
- ⚠ Rinse instruments thoroughly with distilled water, paying close attention to joints and hinges as these areas can accumulate unwanted material.
- ⚠ Air dry your instruments completely and use a can of compressed air to blow out any water at the joints and hinges. Then store them only in clean and dry environments.



ULTRASONIC CLEANING

Ultrasonic cleaning is the most effective cleaning method. The vibrating sound waves create micron-sized bubbles in the solution that grow with the alternating pressure. When the bubbles reach a particular size, they collapse creating a force that dislodges dirt and particles, even in the smallest of crevices.

- ⚠ NOT recommended for delicate and micro instruments.
- ⚠ Follow the manufacturer's guidelines for specific instructions and cleaning cycle times.
- ⚠ Instruments should be processed for the full recommended cycle time.

Place instruments in the open position in the ultrasonic cleaner.

- Do NOT allow instruments with sharp blades to touch other instruments.
- ⚠ • Do NOT place dissimilar metals (stainless, copper, chrome plated) in the same cleaning cycle.
- Make sure all instruments are completely submerged.
- ⚠ After the ultrasonic cleaning cycle is complete, rinse instruments thoroughly to remove all ultrasonic cleaning solution.
- ⚠ Dry instruments thoroughly with a clean towel.
- ⚠ Use a spray lubricant in the hinges to minimize the risk of corrosion and maintain functionality.

STERILIZATION

It is important that instruments are free from all traces of organic or other matter prior to sterilization.

STEAM STERILIZATION/AUTOCCLAVING

The autoclave process utilizes moist heat (or steam) under pressure for sterilization. The steam used must be from distilled water and free of all impurities.

- ⚠ Lubricate all instruments that have any metal to metal interaction such as; scissors, rongeurs, needle holders, hemostats, and retractors. Do NOT use WD-40 or other industrial lubricants.

Instruments may be autoclaved individually or in sets.

- ⚠ • Individual instruments: Disposable wraps or sterilization pouches are ideal. Make sure the pouch size is sufficient for the instrument to be in an open (unlocked) position.
- Instrument sets: Open and unlock all instruments. Place the heavier instruments on the bottom of the set when two layers are needed.
- ⚠ Do NOT lock instruments during autoclaving. This will prevent the steam from reaching and sterilizing the metal to metal surfaces, and heat expansion during autoclaving can cause cracks in the hinge areas.
- ⚠ Do NOT over load the autoclave chamber as this may hinder steam penetration.
- ⚠ Place a towel on the bottom of the pan to absorb excess moisture during autoclaving. Make sure the towel has no detergent residue and is pH neutral if immersed in water.
- ⚠ At the end of the autoclave cycle (before the drying cycle) unlock the autoclave door and open it slightly. Run the dry cycle for the recommended time period by the autoclave manufacturer.

Please note: If the autoclave door is fully opened before the drying cycle, cold air will rush into the chamber, which can cause condensation on the instruments. This will result in water stains on the instruments.





HOT BEAD STERILIZATION

Recommended for speed and convenience when instrument tips or blade sterilization is required. The Hot Bead Sterilizer does not use dangerous gases, flames, or chemicals. Highlights:

- ⚠ Bench top set up.
- ⚠ Only 20 seconds of contact required to ensure your instruments are free of pathogens and microbial contaminants.
- ⚠ Beads reach temperature of 240° - 270 °C (464° - 518 °F) within 15-20 minutes heating time.

Please see page 178 - 179 for more information on the FST Hot Bead Sterilizers.



ETHYLENE OXIDE (ETO) STERILIZATION

This method is recommended for instruments that will not tolerate high temperatures or moisture (e.g., catheters, cannulae, etc.). This is a process consisting of 4 primary variables; gas concentration, humidity, temperature and time.

Sterilization pouches and wraps available, see pages 177 and 180.



STORAGE

Surgical instruments should be properly stored in a clean and dry environment. It is highly recommended to use tip protectors and instrument cases to avoid possible damage to your instruments.

Instrument tip protectors are available, see page 186

Instrument cases are available, see pages 182 - 186

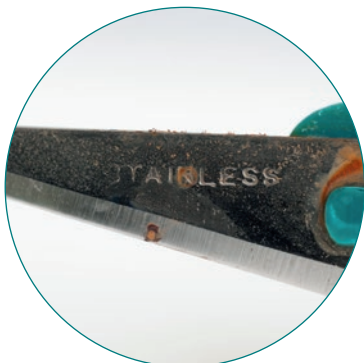

OXIDATION (RUST)

All FST stainless steel surgical instruments are manufactured from medical grade stainless steel under strict European standards. It is very important to properly take care of your instruments to extend their lifespan.

Although stainless steel is corrosive resistant, it can still rust or stain if handled improperly. Under unfavorable conditions instruments may oxidize because stainless steel that is exposed to physical, thermal, or chemical manipulations may lose some of its stainless properties.

SCISSORS, BONE INSTRUMENTS, KNIVES & SCALPELS

Spring Scissors 21 – 33

Fine Scissors 34 – 47

Surgical Scissors 48 – 54

Bone Instruments 55 – 69

Knives & Scalpels 70 – 81



Micro Vannas

These Vannas-style spring scissors have the smallest blades ever produced. They are ideal where space is restricted and where absolute precision is demanded.



MOST POPULAR



MOST POPULAR



Straight Sharp/Sharp

8 cm
Cutting edge: 2.5 mm
Tip Ø: 0.05 mm

No. 15000-08
\$ 317.00



Straight Sharp/Sharp

8 cm
Cutting edge: 2 mm
Tip Ø: 0.05 mm

No. 15000-03
\$ 408.00



Curved Sharp/Sharp

8 cm
Cutting edge: 2 mm
Tip Ø: 0.05 mm

No. 15000-04
\$ 418.00



Curved Sharp/Sharp

8 cm
Cutting edge: 2.5 mm
Tip Ø: 0.05 mm

No. 15001-08
\$ 327.50



Angled to side Sharp/Sharp

8 cm
Cutting edge: 2.5 mm
Tip Ø: 0.05 mm

No. 15002-08
\$ 350.50



Straight Sharp/Sharp

8 cm
Cutting edge: 3 mm
Tip Ø: 0.05 mm

No. 15000-00
\$ 350.00



Curved Sharp/Sharp

8 cm
Cutting edge: 3 mm
Tip Ø: 0.05 mm

No. 15000-10
\$ 360.50

Vannas-Tübingen



**Straight
Sharp/Sharp**

8.5 cm
Cutting edge: 5 mm
Tip Ø: 0.075 mm

No. 15003-08
\$ 355.50



**Angled up
Sharp/Sharp**

9.5 cm
Cutting edge: 5 mm
Tip Ø: 0.075 mm

No. 15005-08
\$ 388.50



**Curved
Sharp/Sharp**

8.5 cm
Cutting edge: 5 mm
Tip Ø: 0.075 mm

No. 15004-08
\$ 368.00



**Angled to side
Sharp/Sharp**

8.5 cm
Cutting edge: 5 mm
Tip Ø: 0.075 mm

No. 15008-08
\$ 380.50



**Straight
Sharp/Sharp**

8.5 cm
Cutting edge: 5 mm
Tip Ø: 0.075 mm

No. 15903-08
\$ 252.00



**Curved
Sharp/Sharp**

8.5 cm
Cutting edge: 5 mm
Tip Ø: 0.075 mm

No. 15904-08
\$ 287.50



**Straight
Sharp/Sharp**

9 cm
Cutting edge: 5 mm
Tip Ø: 0.075 mm

No. 15403-08
\$ 288.50



**Curved
Sharp/Sharp**

9 cm
Cutting edge: 5 mm
Tip Ø: 0.075 mm

No. 15404-08
\$ 298.50

Vannas Spring Scissors High Polished

The highly polished surface makes the scissors more resistant to corrosion and easier to clean. It also prevents tissue from sticking on it while operating, it's also called non-sticky surface.



Vannas Spring Scissors Round Handle

The round handle allows an easy finger adjustment during the application. The hollow grind in the handle reduces the weight. The fine blades are tapered to give a better overview.



Vannas Scissors with Microserrations

Microserrated to minimize slippage.



**Straight
Sharp/Sharp**

8.5 cm
Cutting edge: 7 mm
Tip Ø: 0.1 mm

No. 15007-08
\$ 377.50



**Straight
Sharp/Sharp**

8.5 cm
Cutting edge: 5 mm
Tip Ø: 0.1 mm

No. 15070-08
\$ 382.50



**Curved
Sharp/Sharp**

8.5 cm
Cutting edge: 5 mm
Tip Ø: 0.1 mm

No. 15071-08
\$ 387.50

Vannas



**Straight
Sharp/Sharp**

8 cm
Cutting edge: 5 mm
Tip Ø: 0.125 mm

No. 15044-08
\$ 469.00



**Curved
Sharp/Sharp**

8 cm
Cutting edge: 5 mm
Tip Ø: 0.125 mm

No. 15043-08
\$ 510.00



**Straight
Sharp/Sharp**

8.5 cm
Cutting edge: 8 mm
Tip Ø: 0.1 mm

No. 15009-08
\$ 411.50

Miniature Vannas

Finished under high magnification, these tips are especially useful when incising vessel walls for catheter insertion.

Moria



Moria 9600

Moria 9601



**Straight
Sharp/Sharp**

8 cm
Cutting edge: 5 mm
Tip Ø: 0.15 mm

No. 15396-00
\$ 602.50



**Curved
Sharp/Sharp**

8 cm
Cutting edge: 5 mm
Tip Ø: 0.15 mm

No. 15396-01
\$ 611.50



**Curved
Sharp/Sharp**

9.5 cm
Cutting edge: 5 mm
Tip Ø: 0.3 mm

No. 15615-08
\$ 384.50



**Angled up
Sharp/Sharp**

9.5 cm
Cutting edge: 5 mm
Tip Ø: 0.3 mm

No. 15617-08
\$ 495.50



**Straight
Blunt/Blunt**

6 cm
Cutting edge: 6 mm
Tip Ø: 0.15 mm

No. 15000-12
\$ 403.00



**Curved
Blunt/Blunt**

6 cm
Cutting edge: 6 mm
Tip Ø: 0.15 mm

No. 15000-11
\$ 416.50

Titanium Vannas



**Straight
Sharp/Sharp**

9.5 cm
Cutting edge: 5 mm
Tip Ø: 0.3 mm

No. 15610-08
\$ 375.00



**Straight
Sharp/Sharp**

6 cm
Cutting edge: 6 mm
Tip Ø: 0.1 mm

No. 15000-02
\$ 430.00



**Curved
Sharp/Sharp**

6 cm
Cutting edge: 6 mm
Tip Ø: 0.1 mm

No. 15000-01
\$ 439.00

Spring Scissors

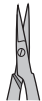

**Straight
Sharp/Sharp**

10 cm
Cutting edge: 8 mm
Tip Ø: 0.15 mm

No. 15024-10
\$ 327.50



**Straight
Blunt/Blunt**

10 cm
Cutting edge: 8 mm
Tip Ø: 0.3 mm

No. 15025-10
\$ 318.50



**Curved
Sharp/Sharp**

10 cm
Cutting edge: 8 mm
Tip Ø: 0.15 mm

No. 15023-10
\$ 339.50

Ceramic Coated Spring Scissors



**Straight
Sharp/Sharp**

10 cm
Cutting edge: 7 mm
Tip Ø: 0.1 mm

No. 15750-11
\$ 339.50



**Curved
Sharp/Sharp**

10 cm
Cutting edge: 7 mm
Tip Ø: 0.1 mm

No. 15751-11
\$ 356.50

Ceramic Coated Titanium Castroviejo



**Straight
Sharp/Sharp**

11 cm
Cutting edge: 5 mm
Tip Ø: 0.2 mm

No. 15650-11
\$ 398.00



**Curved
Sharp/Sharp**

11 cm
Cutting edge: 5 mm
Tip Ø: 0.2 mm

No. 15651-11
\$ 420.00

Castroviejo



**Angled to side
Sharp/Sharp**

10 cm
Cutting edge: 10 mm
Tip Ø: 0.125 mm

No. 15006-09
\$ 341.00

Castroviejo with Ball Tip

Same as No. 15006-09 but with a ball tip (Ø 1.3 mm) to prevent piercing of underlying tissue.



**Angled to side
Sharp/Ball tip**

9 cm
Cutting edge: 8 mm
Tip Ø: 1.3 mm

No. 15033-09
\$ 368.50

Castroviejo



**Curved
Sharp/Sharp**

10 cm
Cutting edge: 10 mm
Tip Ø: 0.2 mm

No. 15017-10
\$ 324.00

Vannas-Wolff

Moria



Moria MC52

Moria MC50



**Straight
Sharp/Sharp**

10 cm
Cutting edge: 7 mm
Tip Ø: 0.15 mm

No. 15370-52
\$ 611.00



**Curved
Sharp/Sharp**

10 cm
Cutting edge: 7 mm
Tip Ø: 0.15 mm

No. 15370-50
\$ 621.00



**Angled up
Sharp/Sharp**

9.5 cm
Cutting edge: 2 mm
Tip Ø: 0.1 mm

No. 15010-09
\$ 321.00



**Angled up
Sharp/Sharp**

10 cm
Cutting edge: 4 mm
Tip Ø: 0.125 mm

No. 15010-10
\$ 308.00



**Straight
Sharp/Sharp**

11.5 cm
Cutting edge: 10 mm
Tip Ø: 0.1 mm

No. 15040-11
\$ 280.50



**Angled up
Sharp/Sharp**

11.5 cm
Cutting edge: 10 mm
Tip Ø: 0.1 mm

No. 15042-11
\$ 306.00

Fine Angled Spring Scissors

These spring scissors aid in cutting tissues from various angles.



Dowell



SPRING SCISSORS

SCISSORS

Vannas



**Straight
Sharp/Sharp**

10.5 cm
Cutting edge: 4 mm
Tip Ø: 0.15 mm

**No. 15018-10
\$ 316.50**



**Curved
Sharp/Sharp**

10.5 cm
Cutting edge: 4 mm
Tip Ø: 0.15 mm

**No. 15019-10
\$ 329.00**

Westcott



**Curved
Sharp/Sharp**

11 cm
Cutting edge: 15 mm
Tip Ø: 0.25 mm

**No. 15015-11
\$ 308.00**

Pascheff-Wolff

Very delicate blades.

Moria



**Angled up
Sharp/Sharp**

10.5 cm
Cutting edge: 3 mm
Tip Ø: 0.15 mm

**No. 15371-92
\$ 606.00**

Moria MC19/B

Noyes

Tungsten Carbide Noyes

Tungsten carbide cutting edges provide long lasting sharpness.



**Straight
Sharp/Sharp**

12 cm
Cutting edge: 14 mm
Tip Ø: 0.2 mm

No. 15012-12
\$ 317.00



**Curved
Sharp/Sharp**

12 cm
Cutting edge: 14 mm
Tip Ø: 0.2 mm

No. 15011-12
\$ 330.00



**Angled up
Sharp/Sharp**

12 cm
Cutting edge: 14 mm
Tip Ø: 0.2 mm

No. 15013-12
\$ 336.50



**Straight
Sharp/Sharp**

12 cm
Cutting edge: 14 mm
Tip Ø: 0.275 mm

No. 15514-12
\$ 430.00

ToughCut® Spring Scissors

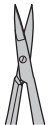

**Straight
Sharp/Sharp**

12.5 cm
Cutting edge: 6 mm
Tip Ø: 0.3 mm

**No. 15124-12
\$ 490.00**



**Curved
Sharp/Sharp**

12.5 cm
Cutting edge: 6 mm
Tip Ø: 0.3 mm

**No. 15123-12
\$ 510.50**



**Straight
Sharp/Sharp**

12.5 cm
Cutting edge: 6 mm
Tip Ø: 0.075 mm

**No. 15400-12
\$ 372.50**



**Curved
Sharp/Sharp**

12.5 cm
Cutting edge: 6 mm
Tip Ø: 0.075 mm

**No. 15401-12
\$ 384.50**



Round Handled Vannas

Round handles allow easy fingertip adjustments.

Spring Scissors



**Straight
Sharp/Sharp**

14 cm
Cutting edge: 6 mm
Tip Ø: 0.15 mm

**No. 15020-15
\$ 415.00**



**Curved
Sharp/Sharp**

14 cm
Cutting edge: 6 mm
Tip Ø: 0.15 mm

**No. 15021-15
\$ 428.50**

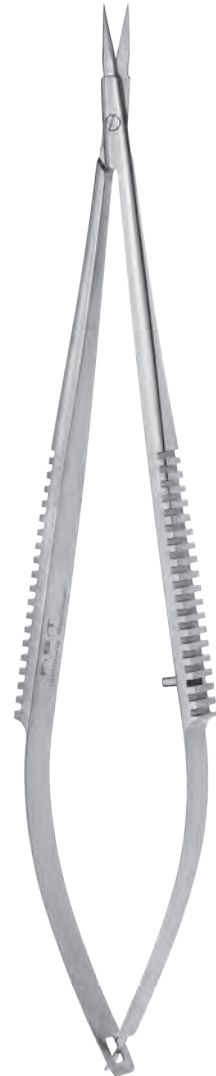

Long Handle Spring Scissors



**Curved
Sharp/Sharp**

18.5 cm
Cutting edge: 5 mm
Tip Ø: 0.2 mm

**No. 15027-18
\$ 318.00**

Trident II

Special design with short handle and inner spring.

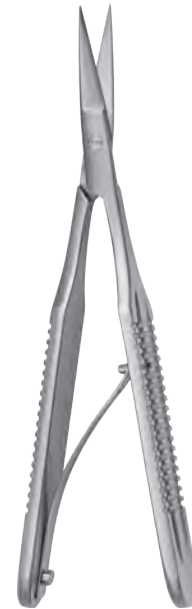

**Straight
Sharp/Sharp**

8 cm
Cutting edge: 8 mm
Tip Ø: 0.2 mm

**No. 15110-08
\$ 333.00**



**Angled to side
Sharp/Sharp**

8 cm
Cutting edge: 8 mm
Tip Ø: 0.2 mm

**No. 15111-08
\$ 341.00**

Micro Scissors

With microserrations to minimize slippage.



300%



**Straight
Sharp/Sharp**

14.5 cm
Cutting edge: 2.5 mm
Tip Ø: 0.175 mm

No. 15030-14
\$ 613.00

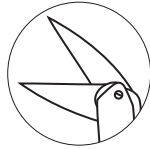

300%



**Angled to side
Sharp/Sharp**

14.5 cm
Cutting edge: 2.5 mm
Tip Ø: 0.175 mm

No. 15031-14
\$ 610.00

Micro Scissors

The finest blades on spring scissors. Designed for ophthalmic surgery (vitrectomy). The spring handles are made of ribbed plastic to ensure a solid grip. **Autoclavable.**

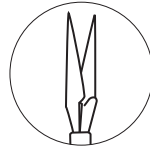

300%



**Straight
Sharp/Sharp**

14 cm
Cutting edge: 2.2 mm
Tip Ø: 0.15 mm

No. 15036-14
\$ 890.00



300%



**Angled to side 90°
Sharp/Sharp**

14 cm
Cutting edge: 1 mm
Tip Ø: 0.1 mm

No. 15037-14
\$ 895.00

Ultra Fine Clipper Scissors II

For microscopic dissections of soft and mucous tissue. The minute fineness of the blades allows clear visualization of the tissue being dissected.



Uses:

- Removing sheath of ganglia to access neurons in aplysia.
- Cutting single nerve axons in aplysia, mollusk and snail.
- Stripping fascia off arteries and muscles.
- Ultra fine brain tissue dissection.
- Cutting of minute fiber optic strands.



**Straight
Sharp/Sharp**

10 cm
Cutting edge: 2 mm
Tip Ø: 0.08 mm
Blade shape: Triangular
0.1 mm Blade thickness

No. 15300-00
\$ 293.50

Biemer Scissors

These scissors are designed to securely cut vessels without slipping.



**Straight
Blunt/Blunt**

8.5 cm
Cutting edge: 4 mm
Tip Ø: 2 mm

No. 15032-08
\$ 300.00

Bonn-Gawenda Scissors

The innovative Bonn-Gawenda scissors from our Exclusive Line combine a precise cutting edge, similar to our spring scissors and our ToughCut® feature which ensures an exact cut without slipping. These scissors have perfect tips for precision work under a microscope. Designed with comfort and ergonomics in mind, the large finger loops and specially engineered handle ensure exceptional control throughout each use.



Straight Sharp/Sharp

10.5 cm
Cutting edge: 10 mm

No. 14854-10
\$ 142.00



Curved Sharp/Sharp

10.5 cm
Cutting edge: 10 mm

No. 14855-10
\$ 149.00



Extra Fine Bonn

Our finest iris scissors, best suited for microdissection under high magnification.



Straight Sharp/Sharp

8.5 cm
Cutting edge: 10 mm

No. 14084-08
\$ 98.00



Curved Sharp/Sharp

8.5 cm
Cutting edge: 10 mm

No. 14085-08
\$ 103.50



Straight Sharp/Blunt

8.5 cm
Cutting edge: 10 mm

No. 14083-08
\$ 89.50

Extra Fine Bonn

Highly polished.



ToughCut® Bonn-Strabismus

A fusion of two light and delicate iris scissors with ToughCut cutting edges.



Hardened Fine Iris Scissors

These scissors have an anti-reflective finish to reduce glare.



**Straight
Sharp/Sharp**

8.5 cm
Cutting edge: 10 mm

No. 14184-09
\$ 91.00



**Curved
Sharp/Sharp**

8.5 cm
Cutting edge: 10 mm

No. 14185-09
\$ 99.00



**Straight
Blunt/Blunt**

8.5 cm
Cutting edge: 10 mm

No. 14084-09
\$ 166.50



**Curved
Blunt/Blunt**

8.5 cm
Cutting edge: 10 mm

No. 14085-09
\$ 171.00



**Straight
Sharp/Sharp**

9 cm
Cutting edge: 16 mm

No. 14090-09
\$ 116.00

11 cm
Cutting edge: 16 mm

No. 14090-11
\$ 118.50



**Curved
Sharp/Sharp**

9 cm
Cutting edge: 16 mm

No. 14091-09
\$ 124.00

11 cm
Cutting edge: 16 mm

No. 14091-11
\$ 122.00

FINE SCISSORS

Fine Iris Scissors

Made from Martensitic stainless steel, combined with Molybdenum and Vanadium.



Iris Scissors

Delicate pattern.



**Straight
Sharp/Sharp**

9 cm
Cutting edge: 16 mm

No. 14060-09
\$ 86.50



**Curved
Sharp/Sharp**

9 cm
Cutting edge: 16 mm

No. 14061-09
\$ 91.00



**Curved to side
Sharp/Sharp**

9 cm
Cutting edge: 16 mm

No. 14062-09
\$ 93.50



**Angled to side
Sharp/Sharp**

9 cm
Cutting edge: 16 mm

No. 14063-09
\$ 99.50



**Straight
Sharp/Sharp**

10.5 cm
Cutting edge: 16 mm

No. 14094-11
\$ 126.50



**Curved
Sharp/Sharp**

10.5 cm
Cutting edge: 16 mm

No. 14095-11
\$ 131.00

10.5 cm
Cutting edge: 16 mm

No. 14060-10
\$ 86.50

10.5 cm
Cutting edge: 16 mm

No. 14061-10
\$ 90.00

10.5 cm
Cutting edge: 16 mm

No. 14062-10
\$ 100.50

11.5 cm
Cutting edge: 16 mm

No. 14060-11
\$ 87.00

11.5 cm
Cutting edge: 18 mm

No. 14061-11
\$ 98.50

Left Handed Iris Scissors



**Straight
Sharp/Sharp**

10.5 cm
Cutting edge: 18 mm

No. 14160-10
\$ 141.50



**Curved
Sharp/Sharp**

10.5 cm
Cutting edge: 18 mm

No. 14161-10
\$ 145.00

Moria Iris Scissors

Moria



Moria 4877A



**Straight
Sharp/Sharp**

12.5 cm
Cutting edge: 10.5 mm

No. 14370-22
\$ 172.50

Extra Narrow Iris Scissors

Extra narrow, delicate pattern. Very slim blades with gentle cutting action.



Side-view showing
extra narrow pattern

**Straight
Sharp/Sharp**

10.5 cm
Cutting edge: 16 mm

No. 14088-10
\$ 98.50

Largo Loops Scissors



Wagner



14070-12
14071-12



**Straight
Sharp/Sharp**

10 cm
Cutting edge: 16 mm

No. 14040-10
\$ 101.50



**Curved
Sharp/Sharp**

10 cm
Cutting edge: 16 mm

No. 14041-10
\$ 108.00



**Straight
Sharp/Sharp**

12 cm
Cutting edge: 20 mm

No. 14068-12
\$ 85.50



**Curved
Sharp/Sharp**

12 cm
Cutting edge: 20 mm

No. 14069-12
\$ 91.00



**Straight
Sharp/Sharp**

12 cm
Cutting edge: 20 mm

No. 14070-12
\$ 96.00



**Curved
Sharp/Sharp**

12 cm
Cutting edge: 20 mm

No. 14071-12
\$ 100.50

Fine Scissors

Lexer-Baby



**Straight
Sharp/Blunt**

10 cm
Cutting edge: 17 mm

No. 14028-10
\$ 90.00



**Curved
Sharp/Blunt**

10 cm
Cutting edge: 17 mm

No. 14029-10
\$ 95.50



**Straight
Blunt/Blunt**

10 cm
Cutting edge: 16 mm

No. 14078-10
\$ 81.50



**Curved
Blunt/Blunt**

10 cm
Cutting edge: 16 mm

No. 14079-10
\$ 88.50

ToughCut®



**Straight
Sharp/Sharp**

9 cm
Cutting edge: 16 mm

No. 14058-09
\$ 94.50

11.5 cm
Cutting edge: 16 mm

No. 14058-11
\$ 97.00



**Curved
Sharp/Sharp**

9 cm
Cutting edge: 16 mm

No. 14059-09
\$ 102.00

11.5 cm
Cutting edge: 16 mm

No. 14059-11
\$ 105.50

Tungsten Carbide



**Straight
Sharp/Sharp**

9 cm
Cutting edge: 16 mm

No. 14568-09
\$ 149.50

11.5 cm
Cutting edge: 16 mm

No. 14568-12
\$ 155.50



**Curved
Sharp/Sharp**

9 cm
Cutting edge: 16 mm

No. 14569-09
\$ 157.00

11.5 cm
Cutting edge: 16 mm

No. 14569-12
\$ 164.00

ToughCut® and Tungsten Carbide

CeramaCut®

These ceramic-coated scissors are the cleanest cutting, longest lasting scissors ever produced. Utilizing the unique properties of a ceramic coating, they will last six times longer than Tungsten Carbide instruments and cut even better than ToughCut® scissors. The black, corrosion-resistant coating has a non-glare finish.



**Straight
Sharp/Sharp**

9 cm
Cutting edge: 16 mm

No. 14558-09
\$ 212.00



**Curved
Sharp/Sharp**

9 cm
Cutting edge: 16 mm

No. 14559-09
\$ 224.50

11.5 cm

Cutting edge: 16 mm

No. 14558-11
\$ 216.50

11.5 cm

Cutting edge: 16 mm

No. 14559-11
\$ 229.00



**Straight
Sharp/Sharp**

9 cm
Cutting edge: 16 mm

No. 14958-09
\$ 325.50



**Curved
Sharp/Sharp**

9 cm
Cutting edge: 16 mm

No. 14959-09
\$ 337.00

11.5 cm

Cutting edge: 16 mm

No. 14958-11
\$ 331.50

11.5 cm

Cutting edge: 16 mm

No. 14959-11
\$ 343.00

Strabismus

Tungsten Carbide Strabismus



**Straight
Blunt/Blunt**

9 cm
Cutting edge: 12 mm

No. 14074-09

\$ 87.50



**Curved
Blunt/Blunt**

9 cm
Cutting edge: 12 mm

No. 14075-09

\$ 91.00

11.5 cm

Cutting edge: 20 mm

No. 14074-11

\$ 86.50

11.5 cm

Cutting edge: 20 mm

No. 14075-11

\$ 89.00



**Straight
Blunt/Blunt**

9 cm
Cutting edge: 12 mm

No. 14574-09

\$ 143.50



**Curved
Blunt/Blunt**

9 cm
Cutting edge: 12 mm

No. 14575-09

\$ 147.50

11 cm

Cutting edge: 20 mm

No. 14574-11

\$ 147.50

11 cm

Cutting edge: 20 mm

No. 14575-11

\$ 154.00

Walton

Stevens Tenotomy



**Curved
Sharp/Sharp**

9.5 cm
Cutting edge: 10 mm

No. 14077-09
\$ 105.00



**Curved
Sharp/Sharp**

10.5 cm
Cutting edge: 10 mm

No. 14077-10
\$ 106.00



**Straight
Sharp/Sharp**

11 cm
Cutting edge: 13 mm

No. 14064-11
\$ 99.50



**Curved
Sharp/Sharp**

11 cm
Cutting edge: 13 mm

No. 14065-11
\$ 103.50



**Straight
Blunt/Blunt**

11 cm
Cutting edge: 13 mm

No. 14066-11
\$ 93.00



**Curved
Blunt/Blunt**

11 cm
Cutting edge: 13 mm

No. 14067-11
\$ 97.00

LaGrange

One edge is serrated to minimize slippage of tissue during cutting.
Curved handle helps when cutting from an awkward angle.



Side-view



**Curved
Sharp/Sharp**

11.5 cm
Cutting edge: 12 mm

No. 14173-12
\$ 119.00

Shea

Transplant scissors with light and delicate pattern.



**Curved
Blunt/Blunt**

12 cm
Cutting edge: 16 mm

No. 14105-12
\$ 122.00

Dissector Scissors

Slim blades for cutting tissue.

**Angled to side
Sharp/Sharp**10 cm
Cutting edge: 6 mm**No. 14081-09**
\$ 105.00**Dissector Scissors**

Similar to 14081-09, but with stronger blades for cutting fine bone.

**Angled to side
Sharp/Sharp**10.5 cm
Cutting edge: 8 mm**No. 14082-09**
\$ 112.00**Spencer Ligature**

Used for cutting stitches or suture.

**Straight
Sharp/Sharp**9 cm
Cutting edge: 16 mm**No. 14076-09**
\$ 69.50

Bonn Artery

Iris scissors with one ball tip to prevent piercing of underlying tissue.



**Straight
Sharp/Ball tip**

9 cm
Cutting edge: 10 mm
1.5 mm Ball Diameter

No. 14086-09
\$ 123.00



**Straight
Sharp/Ball tip**

11.5 cm
Cutting edge: 16 mm
1.5 mm Ball Diameter

No. 14080-11
\$ 110.00

Tissue Separating Scissors



**Straight
Blunt/Blunt**

11.5 cm
Cutting edge: 16 mm

No. 14072-10
\$ 103.00

Graefe

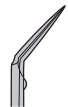

**Angled up
Sharp/Sharp**

10.5 cm
Cutting edge: 12 mm

No. 14037-10
\$ 139.50

Adjustable Loops Fine Scissors

The finger loops can be enlarged to fit almost any size.



**Straight
Sharp/Sharp**

9.5 cm
Cutting edge: 8 mm

No. 14106-09
\$ 93.50



**Straight
Blunt/Blunt**

9.5 cm
Cutting edge: 8 mm

No. 14108-09
\$ 85.00

Kaye

These scissors have semi-sharp outer edges to better facilitate dissection.



**Curved
Blunt/Blunt**

10.5 cm
Cutting edge: 14 mm

No. 14171-10
\$ 116.50

Standard Pattern

Our standard surgical scissors are recognized for these important features:

- Excellent feel and handling capability.
- Overall execution that marks them as fine examples of German craftsmanship.



14008-14



Length (cm)	Cutting edge (mm)	Straight Sharp / Sharp		Straight Sharp / Blunt		Straight Blunt / Blunt	
		No.	Price	No.	Price	No.	Price
12	26	No. 14002-12	\$ 56.00	No. 14001-12	\$ 53.00	No. 14000-12	\$ 50.00
13	28	No. 14002-13	\$ 59.00	No. 14001-13	\$ 56.00	No. 14000-13	\$ 53.00
14.5	30	No. 14002-14	\$ 62.50	No. 14001-14	\$ 59.00	No. 14000-14	\$ 55.50
16.5	36	No. 14002-16	\$ 64.50	No. 14001-16	\$ 62.00	No. 14000-16	\$ 59.00
18.5	40			No. 14001-18	\$ 64.50	No. 14000-18	\$ 62.00
20	44					No. 14000-20	\$ 64.50

Length (cm)	Cutting edge (mm)	Straight Sharp / Blunt	Price
14.5	30	No. 14008-14	\$ 171.00

Length (cm)	Cutting edge (mm)	Curved Sharp / Sharp		Curved Sharp / Blunt		Curved Blunt / Blunt	
		No.	Price	No.	Price	No.	Price
12	26	No. 14005-12	\$ 63.00	No. 14004-12	\$ 59.50	No. 14003-12	\$ 56.00
13	28	No. 14005-13	\$ 65.00	No. 14004-13	\$ 62.00	No. 14003-13	\$ 59.00
14.5	30	No. 14005-14	\$ 69.00	No. 14004-14	\$ 65.50	No. 14003-14	\$ 62.00
16.5	36	No. 14005-16	\$ 71.50	No. 14004-16	\$ 68.00	No. 14003-16	\$ 64.50
18.5	40			No. 14004-18	\$ 71.00	No. 14003-18	\$ 67.00
20	44					No. 14003-20	\$ 70.00

ToughCut® Standard Pattern



75% of actual size

Tungsten Carbide Standard Pattern



75% of actual size



Straight Sharp/Blunt

13 cm
Cutting edge: 28 mm

No. 14054-13
\$ 114.00



Straight Sharp/Blunt

17.5 cm
Cutting edge: 42 mm

No. 14130-17
\$ 122.00



Straight Sharp/Sharp

14.5 cm
Cutting edge: 34 mm

No. 14502-14
\$ 149.50



Straight Sharp/Blunt

14.5 cm
Cutting edge: 34 mm

No. 14501-14
\$ 144.50



Curved Sharp/Sharp

14.5 cm
Cutting edge: 34 mm

No. 14505-14
\$ 151.50

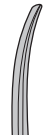

Curved Sharp/Blunt

14.5 cm
Cutting edge: 34 mm

No. 14504-14
\$ 147.50

Standard Pattern with Serrations



75% of actual size

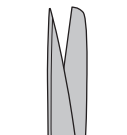

Straight Sharp/Blunt

14 cm
Cutting edge: 30 mm

No. 14007-14
\$ 82.50

Standard Pattern with Large Finger Loops

These finger loops are approximately 1.5x larger than our standard surgical scissors.



80% of actual size



Straight Sharp/Blunt

14.5 cm
Cutting edge: 30 mm

No. 14101-14
\$ 64.00

Lister

Excellent skin cutting scissors. Longer, blunt blade prevents damaging tissue underneath skin without losing the cutting line.



80% of actual size

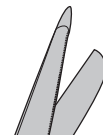

Angled to side Blunt/Blunt

14 cm
Cutting edge: 26 mm

No. 14131-14
\$ 109.50

Metzenbaum Baby

Tungsten Carbide Metzenbaum Fino

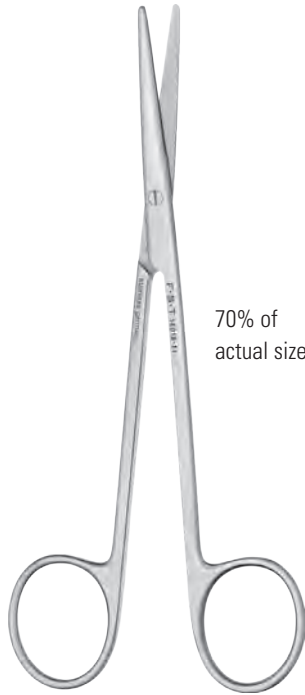

70% of actual size

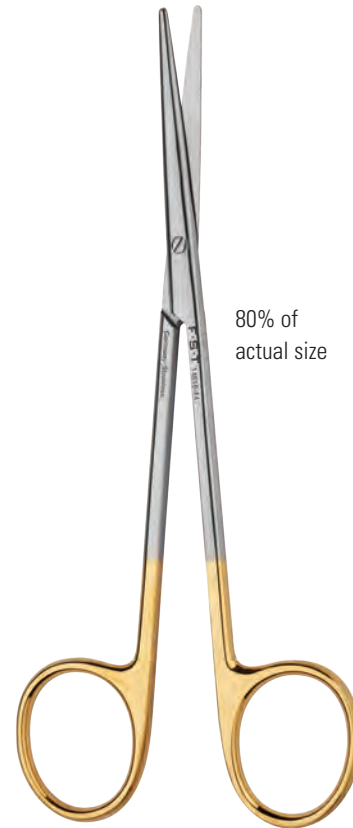

80% of actual size



**Straight
Blunt/Blunt**

13 cm
Cutting edge: 20 mm

No. 14018-13
\$ 101.00



**Curved
Blunt/Blunt**

13 cm
Cutting edge: 20 mm

No. 14019-13
\$ 115.50



**Straight
Ultra fine Blunt/
Blunt**

14.5 cm
Cutting edge: 22 mm

No. 14508-15
\$ 179.00



**Straight
Blunt/Blunt**

14.5 cm
Cutting edge: 22 mm

No. 14518-14
\$ 138.00



**Curved
Ultra fine Blunt/
Blunt**

14.5 cm
Cutting edge: 22 mm

No. 14509-15
\$ 188.00



**Curved
Blunt/Blunt**

14.5 cm
Cutting edge: 22 mm

No. 14519-14
\$ 147.50



14.5 cm
Cutting edge: 22 mm

No. 14018-14
\$ 101.00



14.5 cm
Cutting edge: 22 mm

No. 14019-14
\$ 118.50



18 cm
Cutting edge: 24 mm

No. 14018-18
\$ 110.50



18 cm
Cutting edge: 24 mm

No. 14019-18
\$ 127.50



18 cm
Cutting edge: 24 mm

No. 14518-18
\$ 140.50



18 cm
Cutting edge: 24 mm

No. 14519-18
\$ 152.50

Metzenbaum

ToughCut® Metzenbaum

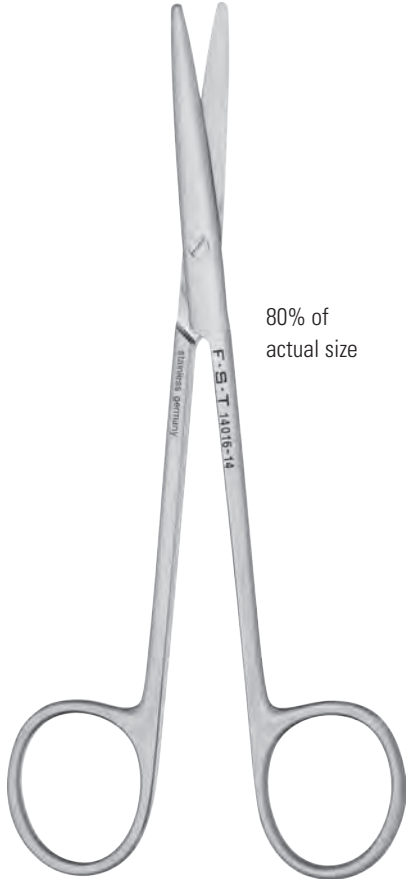

80% of actual size



80% of actual size



Straight Sharp/Blunt

14.5 cm
Cutting edge: 22 mm

No. 14024-14
\$ 82.00



Straight Blunt/Blunt

14.5 cm
Cutting edge: 22 mm

No. 14016-14
\$ 78.50

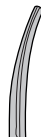

Curved Blunt/Blunt

14.5 cm
Cutting edge: 22 mm

No. 14017-14
\$ 87.00



Straight Blunt/Blunt

14.5 cm
Cutting edge: 22 mm

No. 14116-14
\$ 91.50



Curved Blunt/Blunt

14.5 cm
Cutting edge: 22 mm

No. 14117-14
\$ 100.50

18 cm
Cutting edge: 24 mm

No. 14016-18
\$ 86.00

18 cm
Cutting edge: 24 mm

No. 14017-18
\$ 94.00

18 cm
Cutting edge: 24 mm

No. 14116-18
\$ 98.50

18 cm
Cutting edge: 24 mm

No. 14117-18
\$ 106.50

Mayo

ToughCut® Mayo

Tungsten Carbide Mayo



14512-15 & 14512-17



80% of actual size



80% of actual size



80% of actual size



Straight Blunt/Blunt

15 cm

Cutting edge: 28 mm

No. 14010-15

\$ 77.50

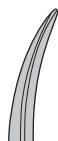

Curved Blunt/Blunt

15 cm

Cutting edge: 28 mm

No. 14011-15

\$ 84.00



Straight Blunt/Blunt

15 cm

Cutting edge: 28 mm

No. 14110-15

\$ 117.00

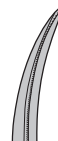

Curved Blunt/Blunt

15 cm

Cutting edge: 28 mm

No. 14111-15

\$ 127.50



Straight Blunt/Blunt

15 cm

Cutting edge: 28 mm

No. 14510-15

\$ 140.00



Curved Blunt/Blunt

15 cm

Cutting edge: 28 mm

No. 14511-15

\$ 147.00

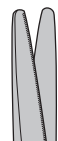

Straight Blunt/Blunt

15 cm

Cutting edge: 28 mm

No. 14512-15

\$ 256.50

17 cm

Cutting edge: 32 mm

No. 14010-17

\$ 80.00

17 cm

Cutting edge: 32 mm

No. 14011-17

\$ 86.50

17 cm

Cutting edge: 32 mm

No. 14110-17

\$ 122.00

17 cm

Cutting edge: 32 mm

No. 14111-17

\$ 132.00

17 cm

Cutting edge: 32 mm

No. 14510-17

\$ 146.50

17 cm

Cutting edge: 32 mm

No. 14511-17

\$ 153.50

17 cm

Cutting edge: 32 mm

No. 14512-17

\$ 265.50

Mayo-Stille



80% of actual size



**Straight
Blunt/Blunt**

15 cm
Cutting edge: 28 mm

No. 14012-15
\$ 69.50

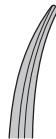

**Curved
Blunt/Blunt**

15 cm
Cutting edge: 28 mm

No. 14013-15
\$ 77.00

17 cm
Cutting edge: 32 mm

No. 14012-17
\$ 74.50

17 cm
Cutting edge: 32 mm

No. 14013-17
\$ 82.00

Mayo-Noble



80% of actual size



**Straight
Blunt/Blunt**

16.5 cm
Cutting edge: 30 mm

No. 14014-17
\$ 96.50

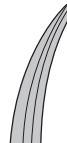

**Curved
Blunt/Blunt**

16.5 cm
Cutting edge: 30 mm

No. 14015-17
\$ 102.00

Decapitation Scissors

Stop guard at tips to prevent slippage.



65% of actual size



**Straight
Blunt/Blunt**

21 cm
Cutting edge: 50 mm

No. 14200-21
\$ 93.00

Micro Friedmann-Pearson Rongeur

Experience the unparalleled precision of our flagship rongeur which features a specialized 0.5 mm cup diameter, tailored for the finest research techniques. These rongeurs guarantee effortless cutting while ensuring captured tissue remains secure and intact.



Cautionary note: The fine rongeur tips shown on this page are extremely fragile. Removal of material with a twisting motion can damage the tips.



200%



Straight

14 cm
Cup size: 0.5 mm

No. 16220-14
\$ 432.00

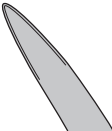

Curved

14 cm
Cup size: 0.5 mm

No. 16221-14
\$ 441.50

Friedmann-Pearson Rongeur

Best suited for delicate work, this is one of our finest tip rongeurs in our product line. The fine-cupped jaws have been designed with a longer and slimmer approach for better visibility.

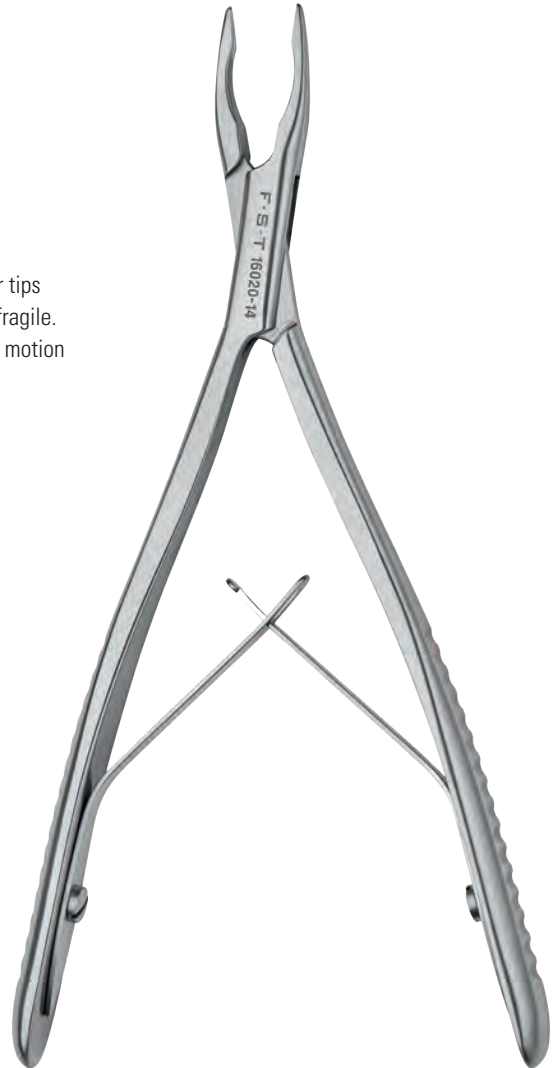
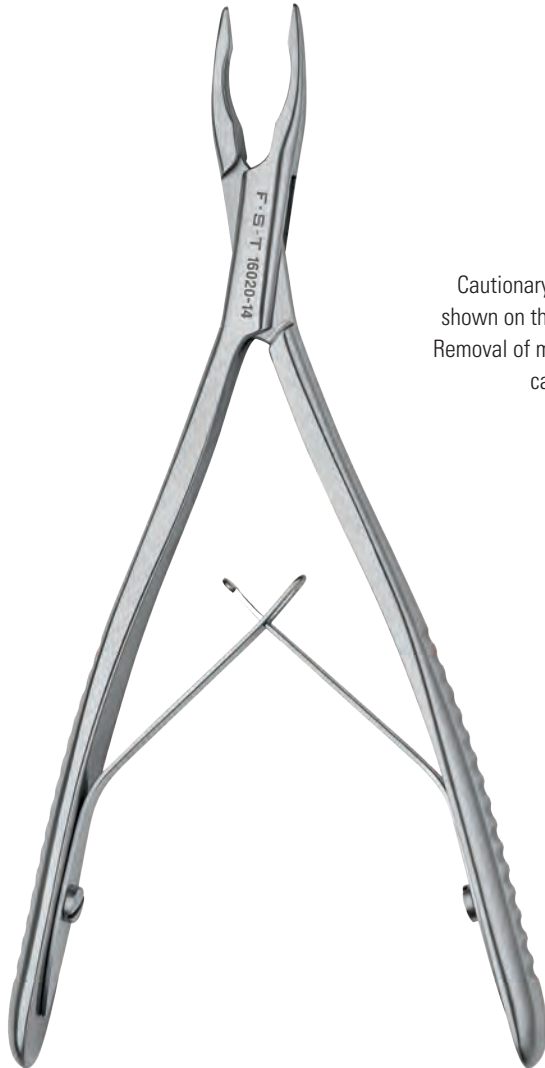

Cautionary note: The fine rongeur tips shown on this page are extremely fragile. Removal of material with a twisting motion can damage the tips.



Straight

14 cm
Cup size: 0.7 mm

No. 16120-14
\$ 400.50

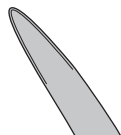

Curved

14 cm
Cup size: 0.7 mm

No. 16121-14
\$ 410.50



Straight

14 cm
Cup size: 1 mm

No. 16020-14
\$ 365.00

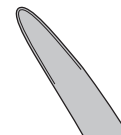

Curved

14 cm
Cup size: 1 mm

No. 16021-14
\$ 375.00

Pearson

Provides excellent visibility at dissection site due to its extra long and narrow approach to the fine cutting jaws. Especially suitable for larger hands.

Luer

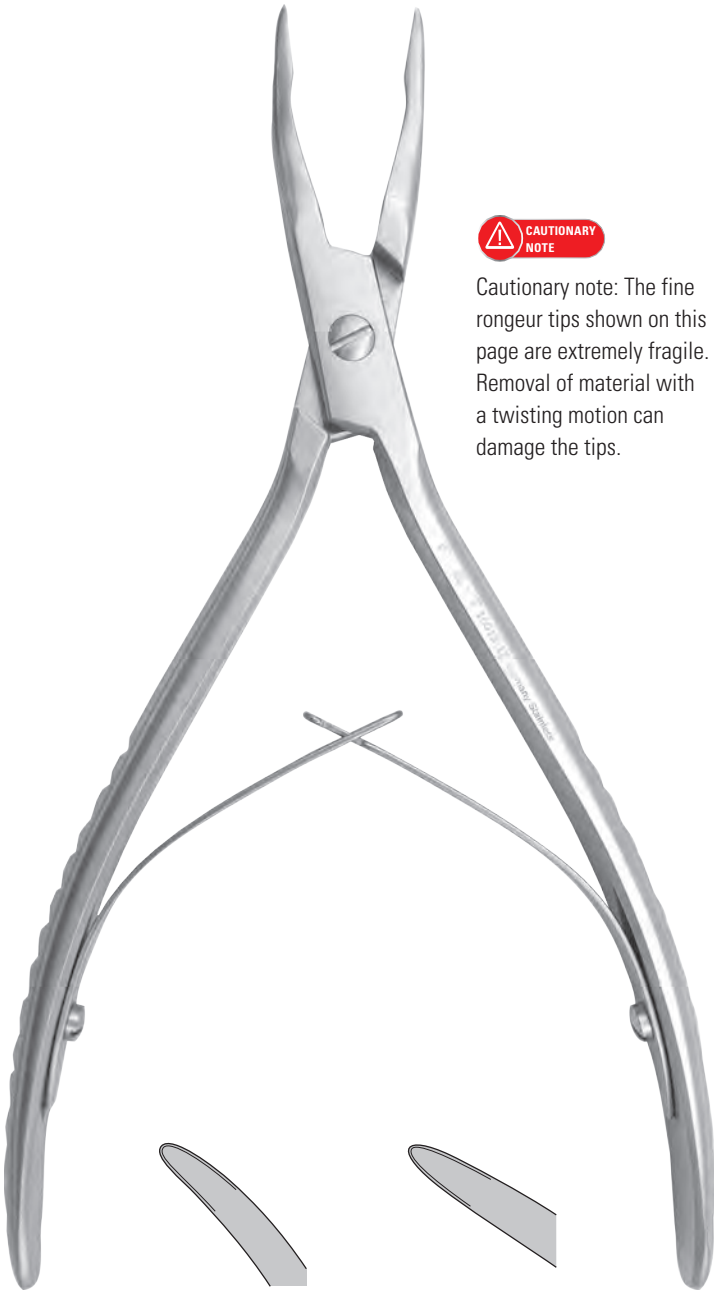

Cautionary note: The fine rongeur tips shown on this page are extremely fragile. Removal of material with a twisting motion can damage the tips.

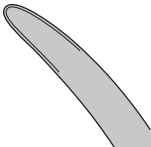

Shallow bend

17 cm
Cup size: 1 mm

No. 16015-17
\$ 403.50

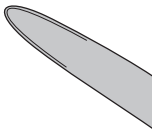

Sharp bend

17 cm
Cup size: 1.2 mm

No. 16016-17
\$ 407.50

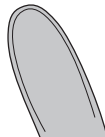

Curved

15 cm
Cup size: 4 mm

No. 16001-15
\$ 262.50

Baby-Beyer

Double-action rongeur with strong jaws helps relieve hand strain.

Beyer

Double-action rongeur with strong jaws helps relieve hand strain.

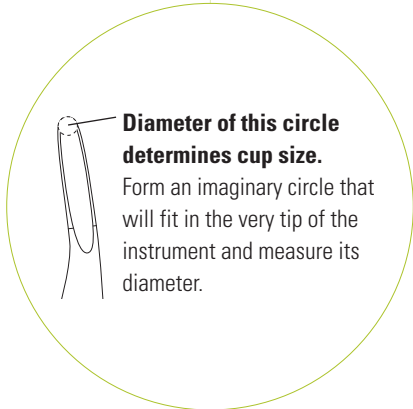

Straight

15 cm
Cup size: 2 mm

No. 16023-15
\$ 392.50

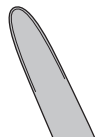

Curved

15 cm
Cup size: 2 mm

No. 16022-15
\$ 402.00

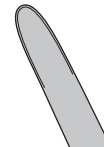

Curved

18 cm
Cup size: 2.5 mm

No. 16002-18
\$ 413.00

Friedmann

Strong and large jaws are ideal for use on the harder, outer regions of the spinal cord. Also can be used to gain access to delicate structures encased in bone.

Lempert

Extra fine jaws.

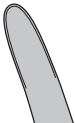

Curved

13 cm
Cup size: 2.5 mm

No. 16000-14
\$ 310.00

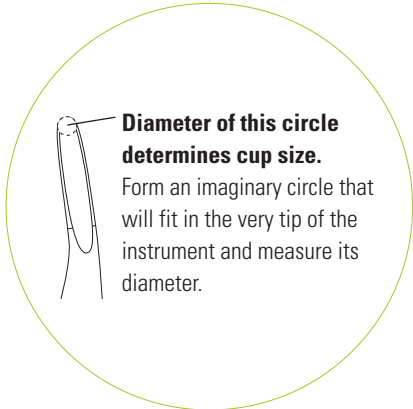

Straight

16 cm
Cup size: 2.5 mm

No. 16004-16
\$ 314.00

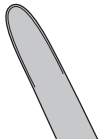

Curved

16 cm
Cup size: 2.5 mm

No. 16005-16
\$ 323.00

Bone Trimmers

Cartilage Cutter

Round cutting blades for tissue, cartilage and soft bone.

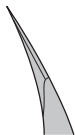

Curved

14 cm
Cutting edge: 8 mm

No. 16109-14
\$ 324.50



Curved

14 cm
Cutting edge: 9 mm

No. 16107-14
\$ 176.50

Dumont #15A Cutter

Cutting edge on both outside and inside bevel.
Cuts suture, cartilage, bone and steel wire to 0.06 mm, and copper wire to 0.15 mm.

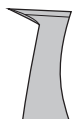

Angled

11.5 cm
Cutting edge: 10 mm
Jaw Opening: 2.5 mm

Hard carbon steel

No. 11215-01
\$ 82.00

Dumont #15ARW Cutter

Same structure and functionality as Item No. 11215-01 (left), but with an epoxy coating up to the cutting edge for easier care and maintenance.

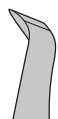

Angled Cutting

11.5 cm
Cutting edge: 6 mm
Jaw Opening: 2.5 mm

Epoxy coated carbon steel

No. 11215-02
\$ 69.50

Tungsten Carbide #15AGHM Cutter

High precision cutting tweezers are suitable for applications which require cutting small material or performing small cuts. The extreme hard Tungsten Carbide blade insert is designed to cut the hardest metals.



Angled Cutting

11.5 cm
Cutting edge: 10 mm
Jaw Opening: 4 mm
Anti-Magnetic Anti-Acid Stainless Steel (SA), sandblasted

No. 11515-02
\$ 89.00

Bone Nipper



Angled up

11 cm
Cutting edge: 5 mm

No. 16102-11
\$ 176.50

Offset Bone Nipper

Strong jaws for cutting tough cartilage.



Angled up

10 cm
Cutting edge: 7 mm

No. 16101-10
\$ 185.50

Malleus Nipper

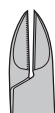

Straight

11 cm
Cutting edge: 9 mm

No. 16140-11
\$ 164.00

Bone Cutting Spring Scissors



**Straight
Blunt/Blunt**

13 cm
Cutting edge: 12 mm

No. 16144-13
\$ 158.50

Delicate Bone Cutting Spring Scissors

Slim, strong blades for cutting fine bones and tissues.

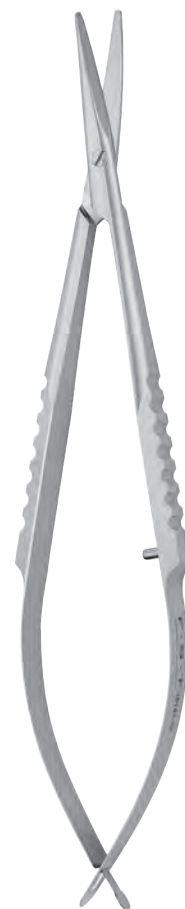

**Curved
Blunt/Blunt**

12 cm
Cutting edge: 12 mm

No. 16143-12
\$ 206.50

CUTTERS

Littauer Bone Cutter



Straight

11 cm
Cutting edge: 15 mm

No. 16152-11
\$ 155.00



Straight

12.5 cm
Cutting edge: 17 mm

No. 16152-12
\$ 158.00



Straight

15 cm
Cutting edge: 19 mm

No. 16152-15
\$ 162.00

Beebee Bone Scissors

Very strong jaws with sharp points.



Straight

10 cm
Cutting edge: 15 mm

No. 16044-10
\$ 66.50

Tungsten Carbide Bone Scissors

Strong heavy blades for cutting bone.



Straight

12.5 cm
Cutting edge: 15 mm

No. 16030-12
\$ 169.50

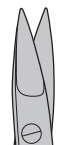

Straight

16 cm
Cutting edge: 15 mm

No. 16030-16
\$ 189.50

Boehler

Bone splitting cutter with very fine tips and double action joint to relieve strain on your hand.



Angled up

15 cm
Cutting edge: 18 mm

No. 16130-15
\$ 503.50

Skull Flap Cutter

One tip has a flat and narrow platform which fits between dura and skull. Other tip has sharp cutting edge. The double action joint relieves strain on your hand.



Angled up

14 cm
Cutting edge: 10 mm

No. 16050-15
\$ 534.50

Cleveland Cutter



Angled up

15 cm
Cutting edge: 15 mm

No. 16106-14
\$ 235.00

17 cm
Cutting edge: 15 mm

No. 16105-16
\$ 250.00

Listen

Gross anatomy bone cutter.



Straight

14 cm
Cutting edge: 20 mm

No. 16104-14
\$ 295.00

20 cm
Cutting edge: 30 mm

No. 16104-19
\$ 318.50

Bone Pliers

To peel back skull flaps.

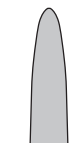

Straight

15.5 cm

No. 16025-14

\$ 269.50

Bone Shears



60% of actual size

Curved

24 cm
Cutting edge: 65 mm

No. 16150-24

\$ 101.50

Bone Forceps

Strong cross-serrated tips for bone crushing and removal.



Angled

11.5 cm
Tip Ø: 1 mm
Cross serrated

No. 16060-11
\$ 96.00

Miniature Self-Tapping Bone Screws

Used extensively to anchor dental cement to bone, these self-tapping screws have superior holding strength over ordinary machine screws. Stainless steel with fillister flat head.



4 mm
Shaft diameter: 0.86 mm
Pkg. of 100 screws

No. 19010-10
\$ 179.50

Pkg. of 10 screws

No. 19010-11
\$ 24.00

For pre-drilling use our 0.7 mm burrs, see page 187.

4.8 mm
Shaft diameter: 1.19 mm
Pkg. of 100 screws

No. 19010-00
\$ 99.50

Pkg. of 10 screws

No. 19010-01
\$ 15.50

For pre-drilling use our 0.9 mm burrs, see page 187.

Bone Wax

A beeswax-based compound for bone hemostasis. Soft, kneadable and ready to use. **Sterile.**



Pkg. of 12 foil packs (2.5 g each)

No. 19009-00
\$ 147.00

Micro Curette

Curette tips consist of a scoop with sharp edges and are used for scraping or cleaning. They can also be used for separating and transporting, inoculating plates or transferring small amounts of chemicals.



Delicate Bone Scraper

For scraping tissue without cutting into bone.



Austin Chisel

Dissecting Chisel



Serrations on cutting edge

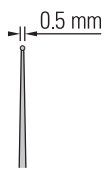

13 cm

No. 10080-05
\$ 121.50

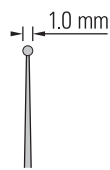

13 cm

No. 10081-10
\$ 122.50

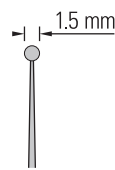

13 cm

No. 10082-15
\$ 122.00

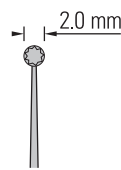

13 cm

No. 10083-20
\$ 147.50

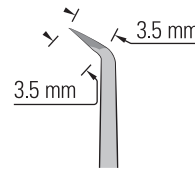

16.5 cm

No. 10075-16
\$ 133.50

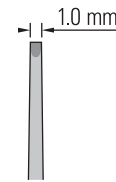

16 cm

No. 10096-16
\$ 132.00

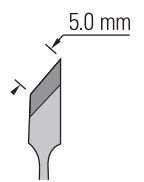

12.5 cm

No. 10095-12
\$ 83.50

Von Graefe Knife

Used for cutting dura.

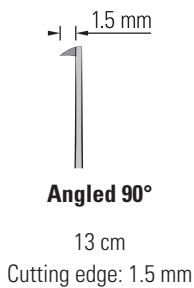

No. 10059-13
\$ 107.50

Cataract Knife

One of the most popular dissecting knives with a microfine point. The cutting edge is lance shaped to provide the ideal cutting angle.

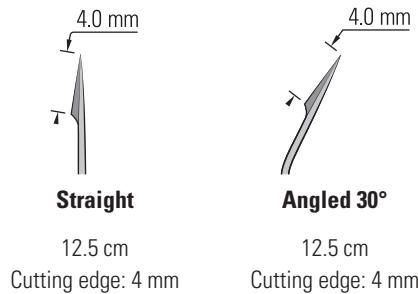

No. 10055-12
\$ 139.00

No. 10056-12
\$ 159.00

Sichel

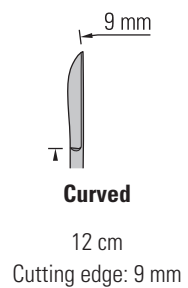

No. 10073-14
\$ 119.00

Micro Knife

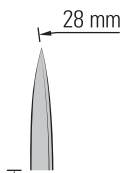

Straight

13 cm
Cutting edge: 28 mm

No. 10370-13
\$ 135.00

Micro Knife Side Cut

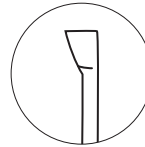

200%

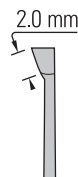

Side cut

15 cm
Cutting edge: 2 mm

No. 10058-15
\$ 175.50

Circle Knife

Sharp cutting edge around tip.

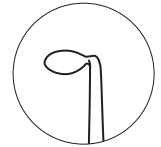

250%

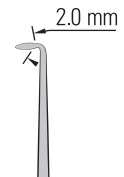

Round

16 cm
Cutting edge: 2 mm

No. 10059-15
\$ 141.00

Gross Anatomy Knives

Handles are made of fiberglass reinforced yellow nylon with a slip resistant surface that allows little chance of bacterial accumulation. The blades are made of German Molybdenum Stainless Steel.



Dissection knives

26 cm
Cutting edge: 13 cm

No. 10157-13
\$ 20.00

28 cm
Cutting edge: 15 cm

No. 10157-15
\$ 24.00

31 cm
Cutting edge: 18 cm

No. 10157-18
\$ 28.00



Brain sectioning knife

44 cm
Cutting edge: 30 cm

No. 10152-30
\$ 48.00

Obsidian Stone Age Scalpels

For applications where extremely fine cuts are required or for studies where trace metals from ordinary scalpel blades cannot be tolerated. These ultra fine cutting edges have been used in human surgical procedures where objectionable scar tissue results from the use of standard scalpels. The blade is made from obsidian—a type of volcanic glass—which allows a much finer blade than is possible with the conventional steel blade. In some cases this makes the relatively inexpensive obsidian scalpel a suitable substitute for an expensive diamond knife. Patterned after “stone age” knives which first made their appearance about 18,000 years ago, these modern versions utilize hard wood and plastic dowels for handles. Plastic dowels are made of polyoxymethylene.



Cautionary note: Obsidian is a very fragile material. Great care should be taken to not exert any lateral pressure on the blade during cutting. Each blade is hand-fashioned, so sizes, shapes and points will vary. While all the blades will have at least one sharp edge, some will have two.

<p>150%</p>	<p>150%</p>	<p>150%</p>	
<p>Wood Dowel Not autoclavable</p>	<p>Plastic Dowel Autoclavable</p>	<p>Plastic Dowel Autoclavable</p>	
<p>Straight</p>	<p>Straight</p>	<p>Straight</p>	<p>Angled</p>
<p>13 cm Cutting edge: 6 mm</p>	<p>13.5 cm Cutting edge: 12 mm</p>	<p>12.5 cm Cutting edge: 6 mm</p>	<p>12.5 cm Cutting edge: 6 mm</p>
<p>No. 10110-01 \$ 85.00</p>	<p>No. 10110-03 \$ 85.00</p>	<p>No. 10110-05 \$ 118.50</p>	<p>No. 10110-07 \$ 126.50</p>

CERAMIC & DIAMOND KNIVES

Ceramic Blades

Advantages:

- Ceramic edge stays sharp 100 times longer than steel edge
- Rust and corrosion free
- Chemical and acid resistant
- Withstands up to 2400 °C (4352 °F)
- No electrostatic discharge concerns
- No trace metal contamination
- Fully nonmagnetic



Angled 45°

33 x 6 x 0.5 mm
Cutting edge: 4.5 mm
Pkg. of 5 blades

No. 10025-44
\$ 170.00

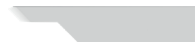

Angled 45°

33 x 6 x 0.5 mm
Cutting edge: 2.5 mm
Pkg. of 5 blades

No. 10025-43
\$ 170.00



Angled 23°

33 x 6 x 0.5 mm
Cutting edge: 14 mm
Pkg. of 5 blades

No. 10025-23
\$ 105.00



Angled 45°

33 x 6 x 0.5 mm
Cutting edge: 8 mm
Pkg. of 5 blades

No. 10025-45
\$ 119.50

Aluminum Alloyed
Handle
12.5 cm

No. 10025-50
\$ 12.00

Diamond Knives

This knife has a gem-quality, neutral diamond blade which is honed to the finest cutting edge possible. The blade is made to an ophthalmic surgical standard and is inspected under 400x magnification. The retractable handle aids in care and storage.



Cautionary note: This blade is extremely fragile and vulnerable to lateral pressure.



Cutting angle: 30°
12 cm
Cutting edge: 1 mm
Tip thickness: 0.15 mm

No. 10100-30
\$ 415.50



Cutting angle: 45°
12 cm
Cutting edge: 1 mm
Tip thickness: 0.15 mm

No. 10100-45
\$ 413.00

Grip slides up the handle to protect the tip for safe storage and packing.

Blade Holders and Breakers

Breakable Carbon Steel Blades

These special, high carbon content blades are the only blades that will break cleanly.

Not autoclavable.



Blade thickness: 0.1 mm
Pkg. of 10 blades

No. 10050-00
\$ 11.50

Create Your Own Blade

With these blade holders/breakers and our special carbon steel blades, No. 10050-00, you can produce microblades in sizes that meet your own individual needs.

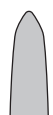
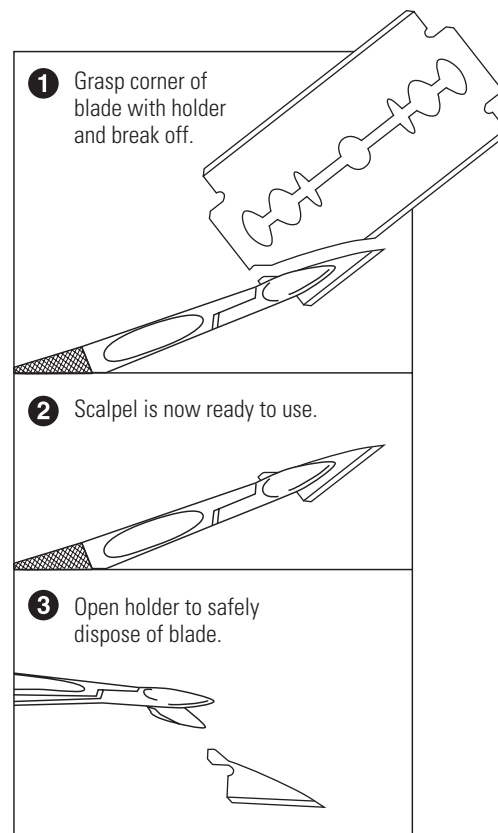

11 cm
Jaw width: 4 mm
Flat surface

No. 10052-11
\$ 255.00



9 cm
Jaw width: 4 mm
Concave / Convex surface
Handle diameter: 5.5 mm

No. 10053-09
\$ 398.50



13 cm
Jaw width: 4 mm
Concave / Convex surface
Handle diameter: 8 mm

No. 10053-13
\$ 404.00

SCALPELS

Carbon Steel Scalpel

Cold forged from carbon steel and sharpened to eliminate tissue distortion and blade drag. 12.5 cm plastic handle with slip-proof grip. **Sterile.**

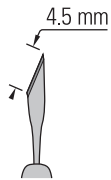

22.5° Cutting angle

13.5 cm
Cutting edge: 4.5 mm
Tip thickness: 0.15 mm

No. 10316-14
\$ 19.00

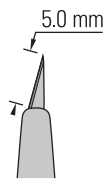

15° Cutting Angle

13 cm
Cutting edge: 5 mm
Tip thickness: 0.15 mm

No. 10315-12
\$ 18.00

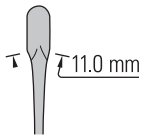

Crescent blade

14 cm
Cutting edge: 11 mm
Tip thickness: 0.2 mm

No. 10317-14
\$ 20.00

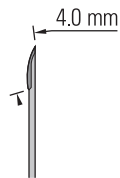

Needle blade

14.5 cm
Cutting edge: 4 mm
Tip thickness: 0.2 mm

No. 10318-14
\$ 38.00

Interchangeable Carbon Steel Blades



Angled Carbon steel

Cutting edge: 10 mm
Pkg. of 5 blades

No. 10035-15
\$ 25.00



Curved Carbon steel

Cutting edge: 10 mm
Pkg. of 5 blades

No. 10035-20
\$ 25.00



Small / Flat Carbon steel

Cutting edge: 1.5 mm
Pkg. of 5 blades

No. 10035-05
\$ 25.50



Large / flat Carbon steel

Cutting edge: 2.75 mm
Pkg. of 5 blades

No. 10035-10
\$ 25.50



Cane Carbon steel

Cutting edge: 12 mm
Pkg. of 5 blades

No. 10035-25
\$ 26.50



Arc Carbon steel

Cutting edge: 12 mm
Pkg. of 5 blades

No. 10035-30
\$ 57.50

Handle for Interchangeable Blades
9.5 cm

No. 10035-00
\$ 62.50

No. 10035-12
\$ 67.00

12.5 cm

Scalpel Handle #4 with Silicone

For heavy, gross anatomy work.
Molded to fit hand.



13.5 cm

No. 10009-13
\$ 52.00

Standard Scalpel Handle #4 Solid

Especially suitable for large dissections.



13 cm

No. 10004-13
\$ 18.50

Blades for #4 Scalpel Handle

The alloy used has a high carbon content which provides a longer lasting edge. Blades come individually wrapped. **Non-sterile.**



#20 blades
Box of 100 blades
No. 10020-00
\$ 56.00



#21 blades
Box of 100 blades
No. 10021-00
\$ 56.00



#22 blades
Box of 100 blades
No. 10022-00
\$ 56.00



#23 blades
Box of 100 blades
No. 10023-00
\$ 56.00

SCALPELS

#3 Standard



12 cm

No. 10003-12
\$ 18.00

#3 Secure

A safety lock holds the blade securely, and allows simple and safe blade attachment and removal.



12 cm

No. 10003-13
\$ 26.50

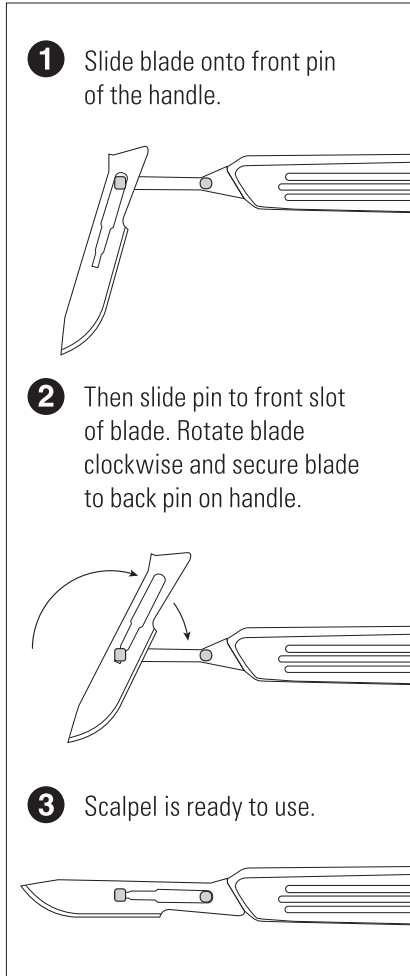

Blades for #3 and #7 Scalpel Handles

The alloy used has a high carbon content which provides a longer lasting edge. Blades come individually wrapped. **Non-sterile.**



#10 blades
Box of 100 blades
No. 10010-00
\$ 56.00



#11 blades
Box of 100 blades
No. 10011-00
\$ 56.00



#12 blades
Box of 100 blades
No. 10012-00
\$ 56.00



#15 blades
Box of 100 blades
No. 10015-00
\$ 56.00

Short Scalpel Handle #7

Standard Scalpel Handle #7

Scalpel Blade Remover

For safe removal of scalpel blades, simply insert scalpel with blade into the Scalpel Blade Remover and press the sides together. This will dislodge the blade from handle and hold the blade securely for release.

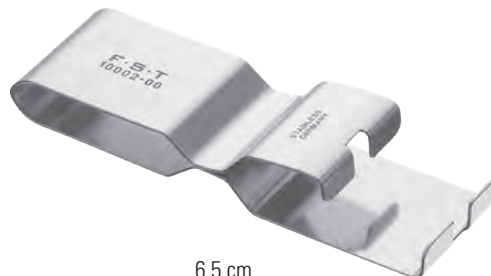

6.5 cm

No. 10002-00

\$ 19.00

Scalpel Blade Remover and Disposal Box

This plastic device will remove used scalpel blades safely and retain them for safe disposal. Can be used for blades that fit the #3, #4, #7 and Gross Anatomy handles.

7.5 x 5 x 2.5 cm

Capacity approximately: 80 blades

Carton of 10 boxes



No. 10002-50

\$ 29.50

12 cm

No. 10007-12

\$ 28.50

16.5 cm

No. 10007-16

\$ 31.50

Your fingers will never come in contact with the blade.

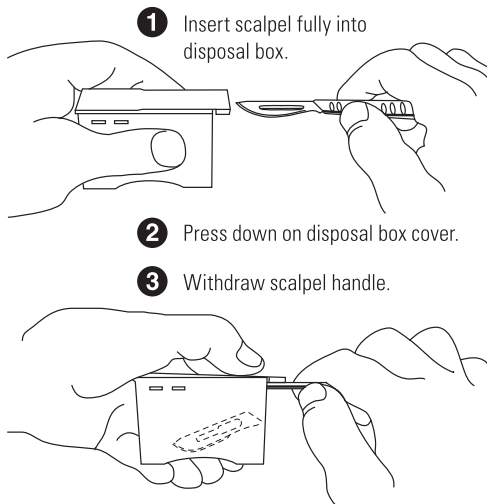

SCALPELS

KNIVES & SCALPELS

Gross Anatomy Blade and Handle

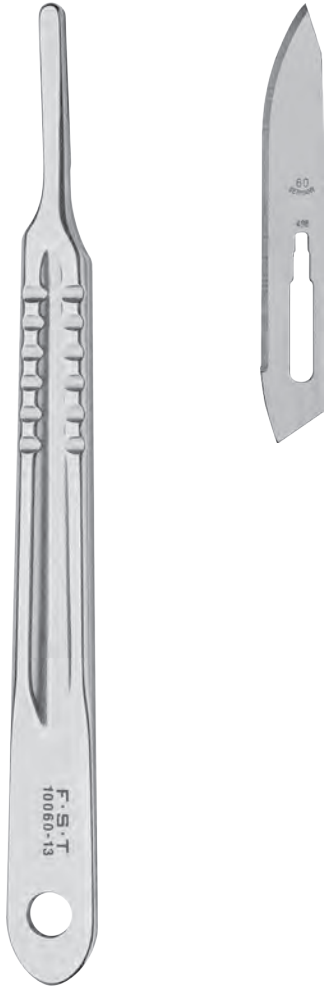

13 cm

No. 10060-13
\$ 22.00

#60 blades

7.5 cm
Box of 100 blades

No. 10060-00
\$ 74.50

Disposable Safety Scalpels

Plastic handle #3 with stainless steel blades. The protective cartridge completely covers the blade for safe, fast and easy disposal. **Single-use and non-sterile.**

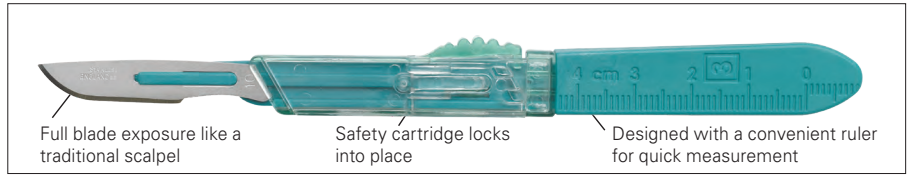

#10 scalpels

14 cm
Pkg. of 10 blades

No. 10000-10
\$ 28.00

#11 scalpels

14 cm
Pkg. of 10 blades

No. 10000-11
\$ 28.00

#15 scalpels

14 cm
Pkg. of 10 blades

No. 10000-15
\$ 28.00

Scalpel shown with safety cartridge closed and locked into place.

Safety Scalpel Blade Cartridges

The Safety Scalpel Handle #3 is compatible with all Safety Scalpel Blades. The handle is reusable and made of Teflon coated stainless steel which provides a non-stick surface. The Blade Cartridges are color-coded with clear windows for easy identification. The protective cartridge completely covers the blade for safe, fast, and easy disposal. **Handle is reusable and autoclavable. Blades are single-use and non-sterile.**

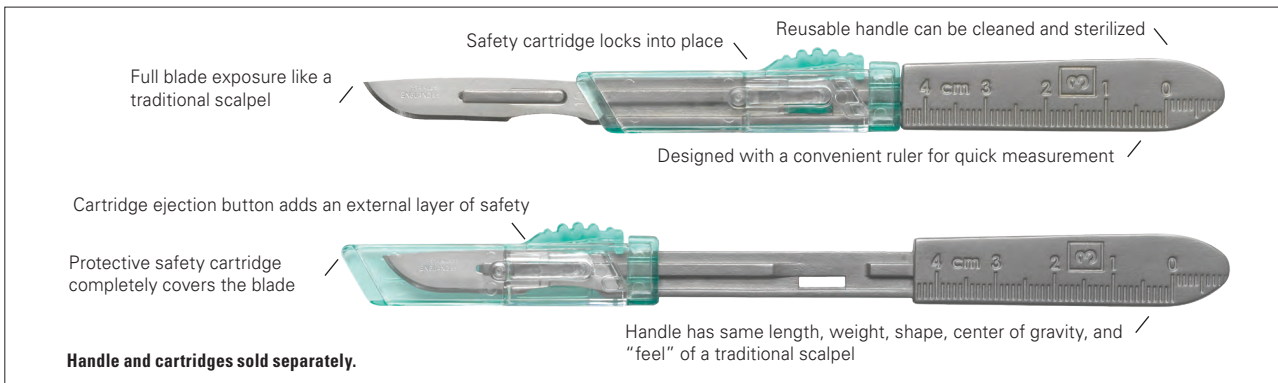

Safety Scalpel Handle #3



12.5 cm
Teflon coated Stainless Steel

No. 10006-12
\$ 26.50

Safety Scalpel Blade Cartridges

Safety Scalpel Blade Cartridges shown open and attached to handle.
Handle and cartridges sold separately.



#10 blades
Pkg. of 10 blades
No. 10010-10
\$ 26.00



#11 blades
Pkg. of 10 blades
No. 10011-10
\$ 26.00



#15 blades
Pkg. of 10 blades
No. 10015-10
\$ 26.00

FORCEPS, TWEEZERS, HEMOSTATS & VASCULAR INSTRUMENTS

FST by Dumont

83 – 92

Fine

93 – 96, 100 – 104

Moria

97 – 98

S&T

99

Standard

105 – 116

Hemostats

117 – 122

Vascular Instruments

123 – 133



Dumont #5SF

The finest tips ever produced by Dumont.

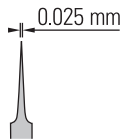

Super fine

11 cm
0.025 x 0.005 mm
Inox

No. 11252-00
\$ 86.50

**Dumont #5
Fine Tips**

Finished under magnification and polished on the inside, the tips close flat to 3 mm and are less likely to open under excess pressure.

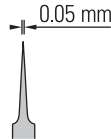

Biology

11 cm
0.05 x 0.01 mm
Inox

No. 11254-20
\$ 56.00

**Dumont #5
Ceramic Coated**

These forceps are non-reflective. The scratch and corrosion resistant coating guarantees durability.

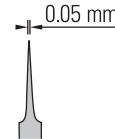

Biology

11 cm
0.05 x 0.01 mm
Ceramic coated Inox

No. 11252-50
\$ 75.50

Dumont #5CO

These forceps have been honed down to make this the lightest and most precise Dumont forceps available.

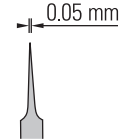

Biology

11 cm
0.05 x 0.01 mm
Dumostar

No. 11295-20
\$ 70.00

FORCEPS/TWEEZERS

**Dumont Medical Micro-Blunted
Atraumatic Tipped Forceps**

The sides of these forceps are distinctively ribbed to provide a better holding surface for maximum control of the instrument. The shanks are arched toward each other to transmit more holding strength to the points. The smooth inside surfaces at the tips will close flat to 5 mm with gentle pressure, increasing the total holding area considerably. The microscopically matched tips are gently blunted to prevent tissue puncture and are recommended as micro needle holders.



FORCEPS/TWEEZERS

Medical #5

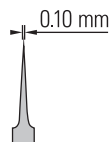

**Standard
Straight**

11 cm
0.1 x 0.06 mm
Inox

No. 11253-20
\$ 44.50

Medical #5A

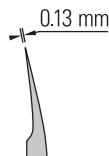

**Standard
Off-Center**

11.5 cm
0.13 x 0.08 mm
Inox

No. 11253-21
\$ 41.00

Medical #7S

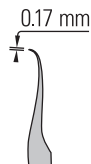

**Standard
Curved**

12 cm
0.17 x 0.1 mm
Inox

No. 11273-22
\$ 49.00

Medical #7

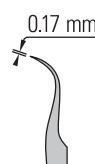

**Standard
Curved**

11.5 cm
0.17 x 0.1 mm
Inox

No. 11273-20
\$ 51.50

Medical #5/45

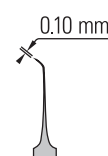

**Standard
Angled 45°**

11 cm
0.1 x 0.06 mm
Inox

No. 11253-25
\$ 50.00

Medical #5/90



**Standard
Angled 90°**

11 cm
0.1 x 0.06 mm
Inox

No. 11253-29
\$ 50.00

Dumont #55

Bevelled, like #5 but with extra light and fine shanks.

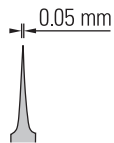

Biology

11 cm
0.05 x 0.02 mm
Inox

No. 11255-20
\$ 46.50

11 cm
0.05 x 0.02 mm
Dumostar

No. 11295-51
\$ 62.00

**Dumont #5
Mirror Finish Forceps**

The last 5 mm on the inside of the tips are highly polished to help prevent tissue from sticking. Ideal for embryos, nerves or any other adhesive tissue.

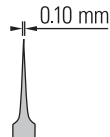

Standard

11 cm
0.1 x 0.06 mm
Inox

No. 11251-23
\$ 76.50

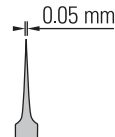

Biology

11 cm
0.05 x 0.02 mm
Inox

No. 11252-23
\$ 79.50

Dumont #5

These are the most widely used Dumont forceps.
Bevelled, very fine shanks for best visibility.



11252-40

11251-10

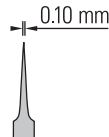

Standard

11 cm
0.1 x 0.06 mm
Inox

No. 11251-20
\$ 37.00

Dumoxel

No. 11251-30
\$ 38.00

Dumostar

No. 11295-00
\$ 55.50

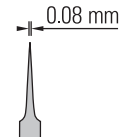

Standard

11 cm
0.08 x 0.04 mm
Carbon steel

No. 11251-10
\$ 36.00

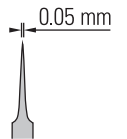

Biology

11 cm
0.05 x 0.02 mm
Inox

No. 11252-20
\$ 44.00

Dumoxel

No. 11252-30
\$ 42.00

Dumostar

No. 11295-10
\$ 64.00

Titanium

No. 11252-40
\$ 46.00

Dumont WA #5

These specially designed forceps offer improved stability with an ergonomic body that allows the forceps to fit more comfortably in your hand. A domed end with no soldering grooves allows the forceps to be thoroughly and easily cleaned, preventing biofilm residues.

Dumont #5XL

FORCEPS/TWEEZERS



Side View

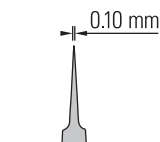

Standard

12 cm
0.10 x 0.06 mm

Inox

No. 11251-21
\$ 40.50

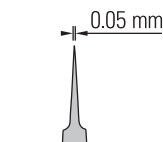

Biology

12 cm
0.05 x 0.02 mm

Inox

No. 11252-21
\$ 44.00

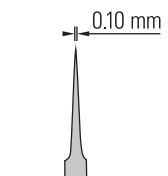

Standard

15 cm
0.1 x 0.06 mm

Inox

No. 11253-10
\$ 59.00

Dumont #L5

Slide sleeve keeps tips together so specimens may be securely held and retained. Slide may be locked in place so that forceps can be used in regular fashion.

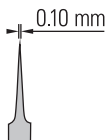

Standard

11 cm
0.1 x 0.06 mm

Inox

No. 11253-27
\$ 72.00

**Dumont #5
Teflon® Coated**

These antimagnetic forceps are ideal for use in cryogenic environments and for EM samples. Teflon® coating provides a non-stick surface.

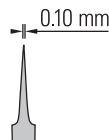

Standard

11 cm
0.1 x 0.06 mm

Teflon coated Inox

No. 11626-11
\$ 49.00

Dumont #5/45

45° tips for improved visibility and control.



Standard

11 cm
0.1 x 0.06 mm

Dumoxel

No. 11251-35
\$ 44.50

**Dumont #5/45
Cover Slip Forceps**

Designed to pick up cover slips out of multi-well plates. The tip width is squared for a better grip.



300%

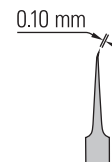

1 mm from tip to bend

11.5 cm
Upper tip: 0.1 x 0.08 mm,
Lower tip: 0.1 x 0.02 mm
Dumoxel

No. 11251-33
\$ 62.00

FORCEPS/TWEEZERS

Dumont #3

Tapered and sturdy shanks.

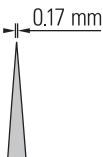

Standard

12 cm
0.17 x 0.1 mm
Dumoxel

No. 11231-30
\$ 35.00

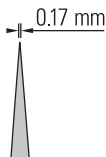

Standard

12 cm
0.17 x 0.1 mm
Dumostar

No. 11293-00
\$ 51.50

Dumont #3c

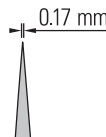

Standard

11 cm
0.17 x 0.1 mm
Inox

No. 11231-20
\$ 32.50

Dumont #6

Sharply angled tips for access to difficult areas.



Standard

11.5 cm
0.17 x 0.1 mm
Inox

No. 11260-20
\$ 44.00

**Dumont #7
Fine Tips**

Finished under magnification and polished on the inside, the tips close flat to 3 mm and therefore less likely to open under excess pressure.

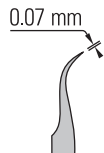

Biology

11.5 cm
0.07 x 0.03 mm
Inox

**No. 11274-20
\$ 50.50**

Dumont #7



11272-40



Biology

11.5 cm
0.07 x 0.04 mm
Dumoxel

**No. 11272-30
\$ 48.50**

Dumostar

**No. 11297-10
\$ 64.50**

Titanium

**No. 11272-40
\$ 54.00**

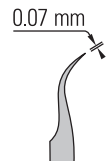

Standard

11.5 cm
0.17 x 0.1 mm
Dumoxel

**No. 11271-30
\$ 43.00**

Dumostar

**No. 11297-00
\$ 58.00**

**Dumont #7
Ceramic Coated**



Biology

11.5 cm
0.07 x 0.04 mm
Ceramic coated Inox

**No. 11272-50
\$ 80.00**

Dumont #7B



Standard

11.5 cm
0.17 x 0.1 mm
Inox

**No. 11270-20
\$ 52.00**

FORCEPS/TWEEZERS

Dumont #4

Similar to #5, but with broader shanks.

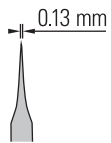

Standard

11 cm
0.13 x 0.08 mm
Dumoxel

No. 11241-30
\$ 37.50

Dumostar

No. 11294-00
\$ 53.50

**Dumont #2
Laminectomy Forceps**

These forceps can be used to break off delicate bone during mouse laminectomies, as well as fine skull bone removal.

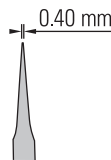

Standard

12 cm
0.4 x 0.02 mm
Inox

No. 11223-20
\$ 43.50

**Dumont #2AP
Epoxy Coated**

Provides good insulation for up to 220 AC voltage work and highly impervious to chemical solutions. Frozen or super cold sections will not adhere to the gripping surfaces.

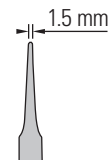

Standard

12 cm
1.5 x 0.7 mm
Epoxy coated Inox

No. 11220-21
\$ 30.00

Dumont AA

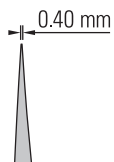

Standard

12.5 cm
0.4 x 0.2 mm
Inox

No. 11210-20
\$ 30.00

**Dumont AA
Epoxy Coated**

Slip-proof acid and electric shock resistant epoxy coating covering 17.5 mm from the tips.

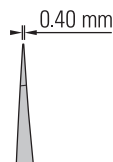

Standard

12.5 cm
0.4 x 0.2 mm
Epoxy coated Inox

No. 11210-10
\$ 29.00

Dumont SS

The tips are smooth on the inside for a gentle grip. Applying full strength will not separate tips and a strong hold on the smallest specimen is ensured.

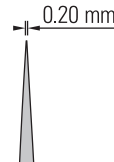

Standard

Straight
13.5 cm
0.2 x 0.12 mm
Inox

No. 11203-23
\$ 39.00

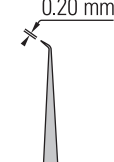
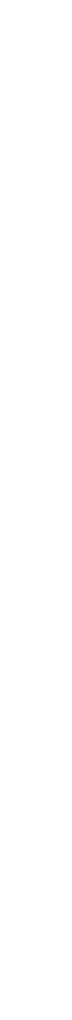

Standard

Angled 45°
13.5 cm
0.2 x 0.12 mm
Inox

No. 11203-25
\$ 45.00

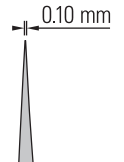

Biology

Straight
13.5 cm
0.1 x 0.06 mm
Dumoxel

No. 11200-33
\$ 40.00

FORCEPS/TWEEZERS

Dumont Mini Forceps

Dumont #2E
Components Forceps

Dumont #5AC

FORCEPS/TWEEZERS



Mini #3

Mini #4

Mini #5

Type #5 Anti-Capillary

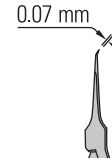
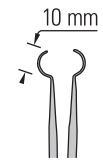
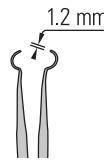
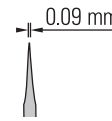
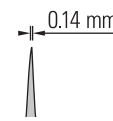
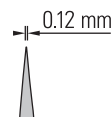

Standard

Standard

Standard

For components

For components

Biology

7 cm
0.12 x 0.07 mm

7 cm
0.14 x 0.06 mm

8.2 cm
0.09 x 0.05 mm

11.5 cm
8 x 1.2 mm

11.5 cm
10 x 1.2 mm

11.5 cm
0.07 x 0.02 mm

Inox

Inox

Inox

Dumoxel

Dumoxel

Inox

No. 11200-10
\$ 25.00

No. 11200-12
\$ 30.50

No. 11200-14
\$ 26.50

No. 11229-08
\$ 46.00

No. 11229-10
\$ 48.00

No. 11258-20
\$ 65.00

Balanced #5 Forceps

These forceps feature an ergonomic design and ultra fine tips for optimal comfort and accuracy. The balanced action of the forceps ensures seamless efficiency during prolonged tasks, providing ease in rotational pivoting with the rounded handle and a counterweight technology providing enhanced control and stability.

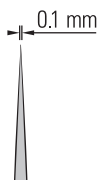

Straight

15 cm
0.1 x 0.06 mm

No. 11851-20
\$ 363.00

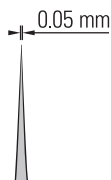

Straight

15 cm
0.05 x 0.02 mm

No. 11852-20
\$ 374.00

Gold Plated Forceps

Gold-plating gives corrosion resistance to most chemicals, salts and acids. These forceps are perfect for any application where corrosion resistance and toughness are primary requirements.

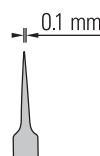

Straight

11 cm
0.1 x 0.06 mm
Gold plated
Stainless Steel

No. 11915-11
\$ 39.00

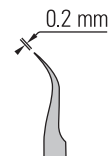

Curved

12 cm
0.2 x 0.1 mm
Gold plated
Stainless Steel

No. 11917-12
\$ 39.50

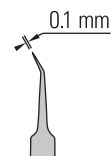

Angled 30°

11 cm
0.1 x 0.06 mm
Gold plated
Stainless Steel

No. 11911-11
\$ 39.00

FORCEPS/TWEEZERS

Diamond Coated Forceps

Diamond coating provides increased corrosion resistance and greater protection from wear and tear, which extends the operational life of the forceps, as well as providing a stronger grip at the tips.

Mirror Finish Broad Shanks

These forceps have long and narrow shanks with thin, highly polished tips to prevent tissue from sticking. Ideal for embryos, nerves, or other adhesive tissues.

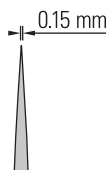

Straight

14 cm
Diamond coated
Stainless Steel
0.15 x 0.1 mm

No. 11990-14
\$ 46.00

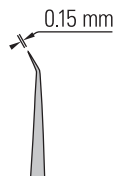

Angled 30°

14 cm
Diamond coated
Stainless Steel
0.15 x 0.1 mm

No. 11991-14
\$ 51.50

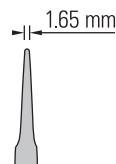

Straight

12 cm
Diamond coated
Stainless Steel
1.65 x 0.05 mm

No. 11992-12
\$ 41.50

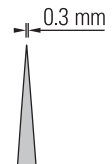

Straight

13 cm
0.3 x 0.15 mm

No. 11923-13
\$ 34.00

Forceps with Replaceable Tips

Stainless steel body with replaceable plastic tips. Tips are made of polyvinylidene fluoride (PVDF) and are electrostatic discharge (ESD) safe. Body and plastic tips are corrosion and abrasion resistant.

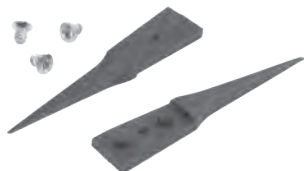

Pkg. of 2 tips and 3 screws
Replacement plastic tips

Straight / Fine

4 cm
0.6 x 0.6 mm

No. 11988-01

\$ 9.50

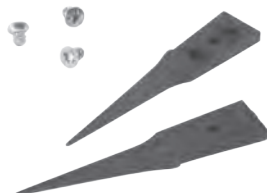

Pkg. of 2 tips and 3 screws
Replacement plastic tips

Straight / Very fine

4 cm
0.5 x 0.5 mm

No. 11988-02

\$ 9.50



Pkg. of 2 tips and 3 screws
Replacement plastic tips

Curved / Very fine

4 cm
0.5 x 0.5 mm

No. 11988-03

\$ 9.50

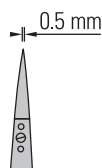

Straight

13 cm
Stainless Steel body
with plastic tips
0.5 x 0.5 mm

No. 11980-13

\$ 27.50

Fine Forceps Mirror Finish

The last 5 mm on the inside of the tips are highly polished to help prevent tissue from sticking. Ideal for embryos, nerves or other adhesive tissue.

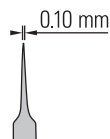

Straight

11 cm
0.1 x 0.06 mm

No. 11412-11

\$ 100.50

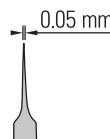

Straight

11 cm
0.05 x 0.02 mm

No. 11413-11

\$ 110.50

Fine Forceps Broad Shanks

Straight forceps with sturdy coarse tips.

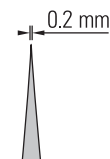

Straight

12 cm
0.2 x 0.12 mm

No. 11445-12

\$ 64.00

#2A Forceps

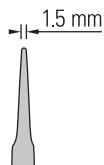

Straight

12 cm
1.5 x 0.1 mm

No. 11992-20
\$ 24.00

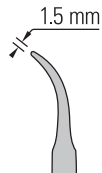

Curved

12 cm
1.5 x 0.1 mm

No. 11972-20
\$ 28.00

Fine Forceps Self-Closing

Ideal for lifting and holding EM grids. Consistent pressure at tips. Correctly tensioned "cross-over" shanks come to a microscopically matched point.

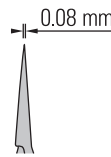

Straight

11.5 cm
0.08 x 0.04 mm

No. 11480-11
\$ 62.50

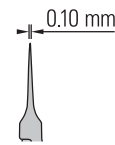

Straight

11 cm
0.1 x 0.06 mm

No. 11485-11
\$ 63.50

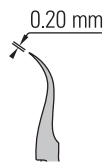

Curved

11.5 cm
0.2 x 0.12 mm

No. 11487-11
\$ 73.50

Moria Ultra Fine Forceps

These forceps have the most finely executed points available. They are extremely light, superbly balanced and have a gentle spring action. The shanks are specially designed with an arch which ensures maximum force to the tips. The tips close flat for 6 mm from the points to give a large holding area. The tips have been expertly finished under magnification.

Moria Iris Forceps

Balanced with gentle spring action and tips that are perfectly matched.



Moria MC40

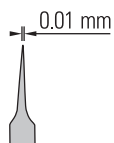

Straight

11 cm
0.05 x 0.01 mm

No. 11370-40
\$ 297.00

Moria MC40/B

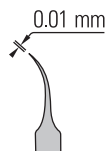

Curved

11 cm
0.05 x 0.01 mm

No. 11370-42
\$ 307.00



Moria 9980

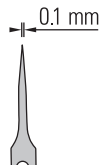

Straight

13 cm
0.1 x 0.06 mm

No. 11399-80
\$ 235.50

Moria 9987

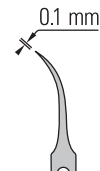

Curved

13 cm
0.1 x 0.06 mm

No. 11399-87
\$ 246.00



Moria MC32/B



Straight
Smooth

10 cm
0.5 x 0.3 mm

No. 11373-22
\$ 211.50

Moria MC31/B

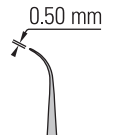

Curved
Smooth

10 cm
0.5 x 0.3 mm

No. 11373-12
\$ 221.50

Moria MC32



Serrated

No. 11370-32
\$ 223.50

Moria MC31

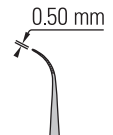

Serrated

No. 11370-31
\$ 234.00

Moria Bonn Forceps

Moria Paufrage Forceps

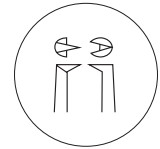

20x magnification

Moria 7835

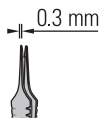

Straight
Tying platform with
1x2 teeth

7.5 cm
Tip width: 0.3 mm
Tying platform: 4 mm
Stainless Steel

No. 11383-50
\$ 350.00

Moria T17835

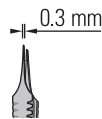

Straight
Tying platform with
1x2 teeth

7.5 cm
Tip width: 0.3 mm
Tying platform: 4 mm
Titanium

No. 11383-56
\$ 360.00

Moria 3225

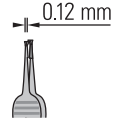

Straight
Tying platform with
1x2 teeth

8.5 cm
Tip width: 0.12 mm
Tying platform: 5 mm
Stainless Steel

No. 11390-25
\$ 185.00

Fine Forceps

SuperGrip Forceps

The tips are processed with MicroCrystals®, a method developed by S&T® to infuse Tungsten Carbide on stainless steel. The formation of this ultra-fine coating guarantees atraumatic handling of tissue while improving the grip dramatically. The recommended use is where forceps are utilized as needle holders or when slippery tissues might be encountered.



300%
The gripping surface is similar to a match head.

FORCEPS/TWEEZERS

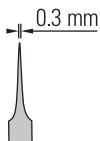

Straight Standard

11 cm
0.3 x 0.25 mm

No. 00108-11
\$ 252.50

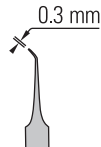

Angled 45° Standard

11 cm
0.3 x 0.25 mm

No. 00109-11
\$ 271.50

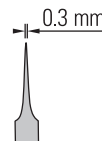

Straight SuperGrip

11 cm
0.3 x 0.25 mm

No. 00632-11
\$ 296.50

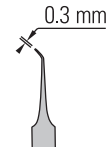

Angled 45° SuperGrip

11 cm
0.3 x 0.25 mm

No. 00649-11
\$ 329.50

FINE FORCEPS

Bonn

The 1x2 teeth forceps No. 11084-07 are the finest of their kind with 0.1 mm wide teeth. The smooth forceps No. 11083-07 have a narrow 5 mm long platform. Both forceps have a pin inside the shanks to limit the applied pressure.

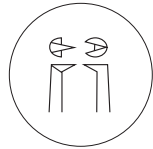

20x magnification

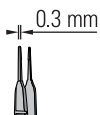

**Straight
Smooth with platform**

7 cm
Tip width: 0.3 mm
Tying platform: 5 mm

No. 11083-07
\$ 284.50

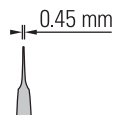

**Straight
1x2 Teeth**

7 cm
Tip width: 0.3 mm
Teeth width: 0.1 mm

No. 11084-07
\$ 319.00

Mirror Finish Bonn Forceps

The fine Bonn forceps features a tying platform and is also available with additional 1x2 teeth. It's designed for tissue manipulation and suturing. The wide handle ensures safe handling. The fine and precise tips make it suitable for work under a high magnification.

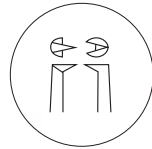

20x magnification

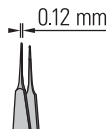

**Straight
Tying platform with
1x2 teeth**

10.5 cm
Tip width: 0.12 mm
Tying platform: 5 mm

No. 11090-10
\$ 188.00

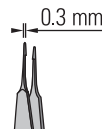

**Straight
Smooth with platform**

10.5 cm
Tip width: 0.3 mm
Tying platform: 5 mm

No. 11093-10
\$ 143.50

Mirror Finish Suture Tying Forceps with Teeth

A unique tip style fusing a suture tying platform and a 1x2 teeth tip for tissue manipulation.

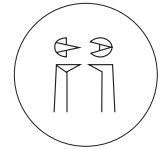

20x magnification

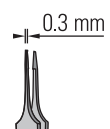

**Straight
Tying platform with
1x2 teeth**

9 cm
Tip width: 0.3 mm
Tying platform: 6 mm

No. 11090-09
\$ 268.00

Moria Suture Tying Forceps

Used to suture after surgery is complete. This requires the manipulation of a calibrated nylon thread and the use of a specific instrument: a tying forceps, straight or curved, without teeth.



Moria 9604

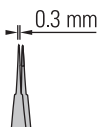

**Straight
Smooth with
platform**

9.5 cm
Tip Ø: 0.3 mm
Tying platform: 8 mm

No. 11393-04
\$ 190.00

Moria 9605

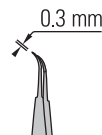

**Curved
Smooth with
platform**

8.5 cm
Tip Ø: 0.3 mm
Tying platform: 7.5 mm

No. 11393-05
\$ 195.00

McPherson Forceps

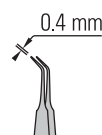

**Angled 45°
Smooth with
platform**

9 cm
Tip Ø: 0.4 mm
Tying platform: 6 mm

No. 11063-07
\$ 174.50

Suture Tying Forceps

The platform tips close flat. This ensures a reliable grip on sutures.

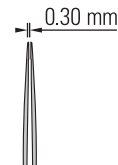
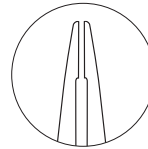

**Straight
Smooth with
platform**

13.5 cm
Tip Ø: 0.3 mm
Tying platform: 6 mm

No. 00272-13
\$ 294.50

Suture Tying Forceps

The platform tips close flat. This ensures a reliable grip on sutures.

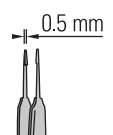

**Straight
Smooth with
platform**

10 cm
Tip Ø: 0.5 mm
Tying platform: 5 mm

No. 18025-10
\$ 166.00

Round Handled Suture Tying Forceps

Round handles allow easy fingertip adjustments.

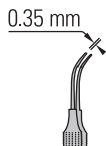

Curved
Smooth with platform

10.5 cm
Tip Ø: 0.35 mm
Tying platform: 5.5 mm

No. 18026-10
\$ 262.00

Vial Forceps

Tips taper for 6 cm allowing easy access to specimens in vials.

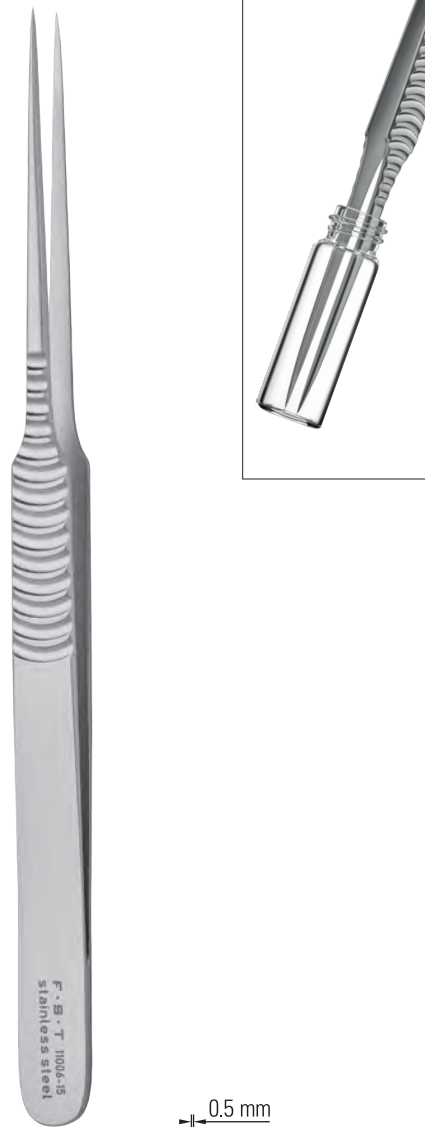

Straight

15 cm
Tip Ø: 0.5 mm

No. 11006-15
\$ 131.50

Graefe Forceps

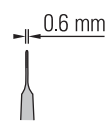

Straight Serrated

7 cm
0.6 x 0.5 mm

No. 11064-07
\$ 81.50

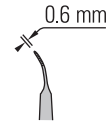

Curved Serrated

7 cm
0.6 x 0.5 mm

No. 11065-07
\$ 89.00

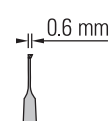

1x2 Teeth

7 cm
0.6 x 0.5 mm

No. 11066-07
\$ 95.50

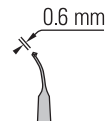

1x2 Teeth

7 cm
0.6 x 0.5 mm

No. 11067-07
\$ 104.50

Bishop-Harman

Extra light, fenestrated handles ensure a good grip.

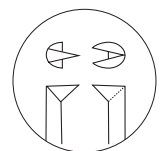

10x magnification

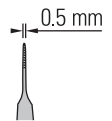

Straight Serrated

8.5 cm
0.5 x 0.5 mm

No. 11069-08
\$ 152.00

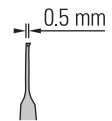

Straight 1x2 Teeth

8.5 cm
0.5 x 0.5 mm

No. 11070-08
\$ 182.00

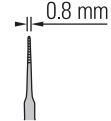

Straight Serrated

9.5 cm
0.8 x 0.5 mm

No. 11040-08
\$ 155.50

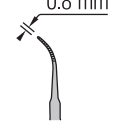

Curved Serrated

9.5 cm
0.8 x 0.5 mm

No. 11041-08
\$ 167.00

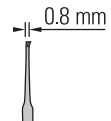

1x2 Teeth

9.5 cm
0.8 x 0.5 mm

No. 11042-08
\$ 169.00

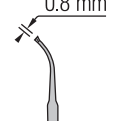

1x2 Teeth

9.5 cm
0.8 x 0.5 mm

No. 11043-08
\$ 175.00

The octagon shaped grip provides a particularly secure finger hold.

FORCEPS/TWEEZERS

Extra Fine Graefe Forceps

Graefe Forceps

FORCEPS/TWEEZERS

The length of all forceps is 10 cm
The dimensions of all tips are 0.5 x 0.5 mm



11650-10 - 11652-10

The length of all forceps is 10 cm

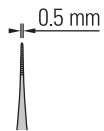

Straight Serrated

No. 11150-10
\$ 81.50

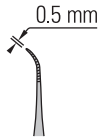

Slightly curved Serrated

No. 11151-10
\$ 87.00



Curved Serrated

No. 11152-10
\$ 90.00

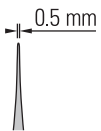

Straight Smooth

No. 11158-10
\$ 72.50

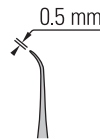

Slightly curved Smooth

No. 11159-10
\$ 77.50

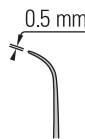

Curved Smooth

No. 11160-10
\$ 78.50

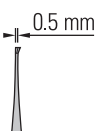

Straight 1x2 Teeth

No. 11153-10
\$ 93.00

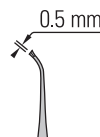

Slightly curved 1x2 Teeth

No. 11154-10
\$ 99.50



Curved 1x2 Teeth

No. 11155-10
\$ 100.50

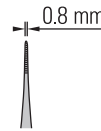

Straight Serrated

0.8 x 0.7 mm

No. 11050-10
\$ 62.50

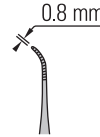

Slightly curved Serrated

0.8 x 0.7 mm

No. 11051-10
\$ 69.50



Curved Serrated

0.8 x 0.7 mm

No. 11052-10
\$ 69.00

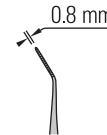

Angled Serrated

0.8 x 0.7 mm

No. 11049-10
\$ 70.00

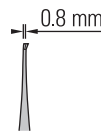

Straight 1x2 Teeth

0.8 x 0.7 mm

No. 11053-10
\$ 78.50

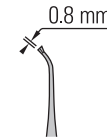

Slightly curved 1x2 Teeth

0.8 x 0.7 mm

No. 11054-10
\$ 83.50



Curved 1x2 Teeth

0.8 x 0.7 mm

No. 11055-10
\$ 85.00

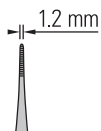

Straight Serrated

1.2 x 0.9 mm
Titanium

No. 11650-10
\$ 156.00

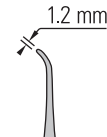

Slightly curved Serrated

1.2 x 0.9 mm
Titanium

No. 11651-10
\$ 163.00

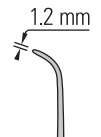

Curved Serrated

1.2 x 0.9 mm
Titanium

No. 11652-10
\$ 165.50



Sliding Lock Forceps



**Straight
Smooth**

11 cm
1 x 0.75 mm

No. 11062-10
\$ 122.50

Episcleral Forceps

The tips of these forceps arch toward each other, closing flat. Exceptional gripping power is possible with minimal damage to tissue. A limit pin prevents excessive applied pressure.

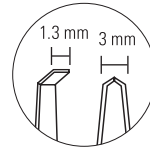

300%



**Straight
Arched**

10 cm
1.3 x 3 x 0.2 mm

No. 11071-10
\$ 155.50

Pierse Fixation Forceps

For exceptional gripping power with no damage to sclera, vascular sheath and epineurium.

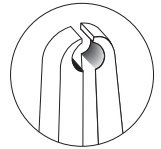

1800%

Tissue retention
hole of 0.3 mm
behind tips.



**Straight
0.3 mm Hole**

13 cm
1 x 0.5 mm

No. 18155-13
\$ 167.50

FORCEPS/TWEEZERS

STANDARD FORCEPS

Plastic Forceps

These forceps are non-magnetic, acid resistant and able to withstand temperatures up to 240 °C (464 °F). Tips do not spread under pressure. Plastic forceps are made of Acetyl and will be sold in packages of 10 pieces.

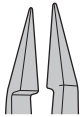

Straight Sharp

11.5 cm
0.4 x 0.25 mm

No. 11700-00

\$ 26.50



Curved Sharp

11.5 cm
0.3 x 0.2 mm

No. 11700-01

\$ 26.50

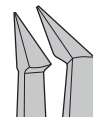

Angled 45° Sharp

11.5 cm
0.3 x 0.2 mm

No. 11700-02

\$ 26.50

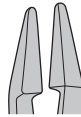

Straight Blunt

11.5 cm
1.5 x 0.4 mm

No. 11700-03

\$ 26.50

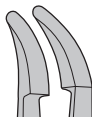

Curved Blunt

11.5 cm
1.5 x 0.4 mm

No. 11700-04

\$ 26.50

Cross Action Forceps

These tissue transport forceps have a gentle action.

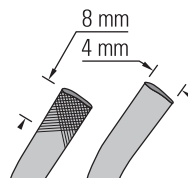

Angled Cross serrated

10 cm
4 x 8 mm

No. 11075-00

\$ 69.00

Cover Glass Forceps

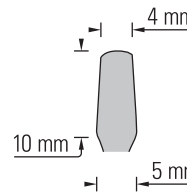

Straight Smooth

10.5 cm
4 x 10 x 0.6 mm

No. 11074-02

\$ 32.50

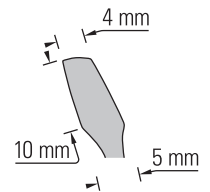

Angled Smooth

10.5 cm
4 x 10 x 0.6 mm

No. 11073-10

\$ 39.50

Ring Forceps

For transport of tissue and organs. With limit screw to prevent excessive applied pressure.



Straight Ring

8.5 cm
ID: 1 mm OD: 1.5 mm x 0.5 mm

No. 11101-09
\$ 73.50



Straight Ring

9 cm
ID: 2.2 mm OD: 3 mm x 1.3 mm

No. 11103-09
\$ 66.50



Straight Ring

9 cm
ID: 4.8 mm - OD: 6 mm x 1.5 mm

No. 11106-09
\$ 65.50

Circle Forceps

Cupped forceps for atraumatic gripping of organs and tissues.



Straight Circle

11.5 cm
7 x 0.5 mm

No. 11072-11
\$ 31.50

Live Insect Handling Forceps

Very delicate.



Straight Narrow

10 cm
0.9 x 0.15 mm

No. 26029-10
\$ 36.00



Straight Wide

10 cm
2.3 x 0.3 mm

No. 26030-10
\$ 31.50

STANDARD FORCEPS

Micro-Adson

Our most delicate version of the popular Adson forceps.



Straight Serrated

12 cm
0.8 x 0.9 mm

No. 11018-12
\$ 62.00

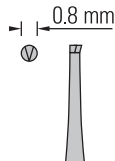

Straight 1x2 Teeth

12 cm
0.8 x 1.3 mm

No. 11019-12
\$ 68.00

Micro-Adson with Fenestrated Handle

Our delicate Micro-Adson forceps, with five windows to aid in stability and easy finger adjustments.

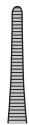

Straight Serrated

12 cm
0.8 x 1 mm

No. 11020-12
\$ 65.00

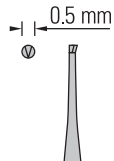

Straight 1x2 Teeth

12 cm
0.5 x 0.6 mm

No. 11032-12
\$ 76.00

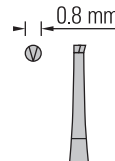

Straight Tying platform with 1x2 teeth

12 cm
0.8 x 2 mm
Tying platform: 6 mm

No. 11022-12
\$ 63.00

Adson

Wide, strong grip with narrow tips.



11506-12



Straight Serrated

12 cm
1.5 x 1 mm

No. 11006-12
\$ 36.50

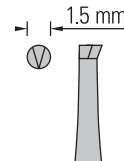

Straight 1x2 Teeth

12 cm
1.5 x 2 mm

No. 11027-12
\$ 39.50

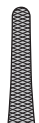

Straight Cross Serrated Tungsten Carbide

12 cm
1.5 x 1.3 mm

No. 11506-12
\$ 148.00

Adson DeBakey

Ideal for gentle, atraumatic gripping of vessels, tissue and other delicate structures. Two rows of atraumatic teeth interfit with one opposite row of atraumatic teeth.



Atraumatic DeBakey Serrations

This tooth pattern, as shown, consists of one row of atraumatic teeth meshed with two opposite rows of atraumatic teeth.

These two forceps are ideal for gentle, atraumatic gripping of vessels, tissue and other delicate structures.

Adson-Graefe



Adson-Brown



FORCEPS/TWEEZERS

Straight DeBakey serrations

12.5 cm
1.75 x 1.5 mm

No. 11617-12
\$ 160.00

Straight DeBakey serrations

15 cm
1.75 x 1.5 mm

No. 11616-15
\$ 166.00

Straight Fine teeth

12.5 cm
4.5 x 1.25 mm

No. 11030-12
\$ 135.50

Straight Shark teeth

12 cm
2 x 1.4 mm

No. 11627-12
\$ 76.50

STANDARD FORCEPS

Standard Pattern

Broad pattern with strong spring action.

FORCEPS/TWEEZERS



Straight Serrated

Length (cm)	Tip width (mm)	Item	Price
12	2.5	No. 11000-12	\$ 22.00
13	2.8	No. 11000-13	\$ 25.00
14.5	3.25	No. 11000-14	\$ 28.00
16	3.3	No. 11000-16	\$ 31.00
18	3.7	No. 11000-18	\$ 34.00
20	3.75	No. 11000-20	\$ 37.00
25	3.9	No. 11000-25	\$ 42.00
30	4	No. 11000-30	\$ 48.50

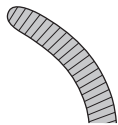

Curved Serrated

Length (cm)	Tip width (mm)	Item	Price
12	2.5	No. 11001-12	\$ 29.00
13	2.8	No. 11001-13	\$ 32.50
14.5	3.25	No. 11001-14	\$ 35.00
16	3.3	No. 11001-16	\$ 37.50
18	3.7	No. 11001-18	\$ 39.00
20	3.75	No. 11001-20	\$ 41.00

Narrow Pattern

Lighter spring action than standard pattern for grasping more delicate tissue.



11602-14



Straight Serrated

Length (cm)	Tip width (mm)	Item	Price
12	2	No. 11002-12	\$ 27.50
13	2.15	No. 11002-13	\$ 30.50
14.5	2.25	No. 11002-14	\$ 33.50
14.5	2.25	No. 11602-14	\$ 105.00
16	2.35	No. 11002-16	\$ 36.50
18	2.4	No. 11002-18	\$ 42.50
20	2.75	No. 11002-20	\$ 43.50
25	3.2	No. 11002-25	\$ 46.50

TITANIUM

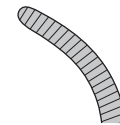

Curved Serrated

Length (cm)	Tip width (mm)	Item	Price
12	2	No. 11003-12	\$ 33.50
13	2.15	No. 11003-13	\$ 35.50
14.5	2.25	No. 11003-14	\$ 41.00
16	2.35	No. 11003-16	\$ 41.50
18	2.4	No. 11003-18	\$ 44.00
20	2.75	No. 11003-20	\$ 47.00

Semken

The Semken tweezers are characterized by their slim shape and fine tips. Their anatomical (toothing) or surgical (1x2 teeth) tips make them ideal for grasping tissue. The serrated grip surface ensures a secure hold during use.



11608-15



Straight Serrated

13 cm
Tip width: 1.3 mm

No. 11008-13
\$ 40.00

15 cm
Tip width: 1.5 mm

No. 11008-15
\$ 43.00

15 cm
Tip width: 1.5 mm
Titanium

No. 11608-15
\$ 167.00

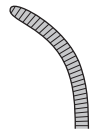

Curved Serrated

13 cm
Tip width: 1.3 mm

No. 11009-13
\$ 45.00

15 cm
Tip width: 1.5 mm

No. 11009-15
\$ 48.50



Straight 1x2 Teeth

12.5 cm
Tip width: 1.3 mm

No. 11024-12
\$ 40.50

DeBakey Round Handle Forceps

Ideal for gentle, atraumatic gripping of vessels, tissue and other delicate structures. Two rows of atraumatic teeth interfit with one opposite row of atraumatic teeth. The round handles allow easy fingertip adjustments.



Straight DeBakey serrations

15 cm
Tip width: 1.2 mm

No. 11076-15
\$ 225.00

STANDARD FORCEPS

Multipurpose Forceps

Balanced instruments are designed to put the center of gravity between the thumb and index finger. This is accomplished by adding a slight counter weight to the proximal end of the instruments. The design enhances tactile feel, aiding in better control and precision.

The tips of these multipurpose forceps are configured to enable their use as dilators at the front, as well as needle holders and tying forceps further in the back. The platform at the tips close parallel ensuring a reliable grip.



Straight
For Dilating and Suture tying

14.5 cm
Tip Ø: 0.1 mm

No. 18601-15
\$ 309.50



Straight
For Dilating and Suture tying

15 cm
Tip Ø: 0.3 mm

No. 18602-15
\$ 292.00



Angled
For Dilating and Suture tying

14.5 cm
Tip Ø: 0.2 mm

No. 18603-14
\$ 274.50

Tissue Forceps



**Straight
1x2 Teeth / Narrow**

10 cm

No. 11023-10
\$ 37.50

12 cm

No. 11023-12
\$ 37.00

14.5 cm

No. 11023-14
\$ 39.00

15.5 cm

No. 11023-15
\$ 41.00



**Straight
1x2 Teeth / Standard**

12 cm

No. 11021-12
\$ 25.50

14.5 cm

No. 11021-14
\$ 27.50

15.5 cm

No. 11021-15
\$ 29.50



**Straight
2x3 Teeth / Standard**

14.5 cm

No. 11022-14
\$ 39.00

15.5 cm

No. 11022-15
\$ 41.50

Tissue Forceps

Used with rongeur No. 16021-14 in laminectomy to securely hold spinal column.



**Curved
1x2 Teeth / Narrow**

14 cm

No. 11029-14
\$ 39.50

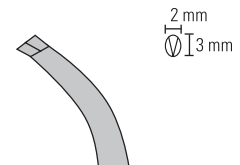

Gillies

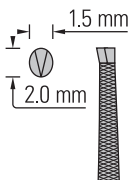

Straight
1x2 Teeth & cross serrated

15 cm
1.5 x 2 mm

No. 11028-15
\$ 48.00

Russian

Special cupped pattern for superior grip.

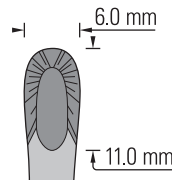

Straight
Cupped teeth

15 cm
6 x 11 mm

No. 11026-15
\$ 62.00

Organ Holding Forceps

With limit screw to prevent excessive applied pressure.

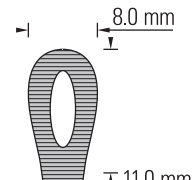

Straight
Serrated

14.5 cm
8 x 11 mm

No. 11031-15
\$ 140.50

London Forceps

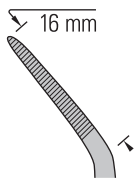

Angled Serrated

16 cm
1 x 0.9 mm

No. 11080-02
\$ 30.00

Titanium Forceps



Straight Serrated

16 cm
0.3 x 0.5 mm

No. 11602-16
\$ 153.50

Gerald Forceps



Straight Serrated

18 cm
1.4 x 1 mm

No. 11014-18
\$ 61.50

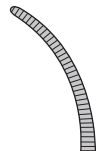

Curved Serrated

18 cm
1.4 x 1 mm

No. 11015-18
\$ 67.50

FORCEPS/TWEEZERS

STANDARD FORCEPS

Taylor Forceps

Serrated and smooth versions available.

FORCEPS/TWEEZERS



Straight Serrated

17 cm
1.5 x 1 mm

No. 11010-17

\$ 60.00

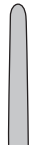

Straight Smooth

17 cm
1.5 x 1 mm

No. 11016-17

\$ 51.50

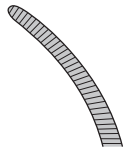

Curved Serrated

17 cm
1.5 x 1 mm

No. 11011-17

\$ 68.00

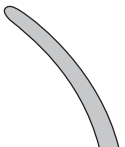

Curved Smooth

17 cm
1.5 x 1 mm

No. 11017-17

\$ 61.50

Potts-Smith Forceps



Straight Serrated

18 cm
1.25 x 1 mm

No. 11012-18

\$ 56.50

21 cm
1.8 x 1.5 mm

No. 11012-21

\$ 59.00

25 cm
2 x 1.6 mm

No. 11012-25

\$ 65.00

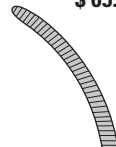

Curved Serrated

18 cm
1.25 x 1 mm

No. 11013-18

\$ 61.00

21 cm
1.8 x 1.5 mm

No. 11013-21

\$ 65.00

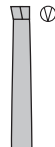

Straight 1x2 Teeth

18 cm
1.25 x 1 mm

No. 11024-18

\$ 60.00

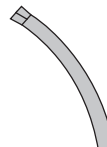

Curved 1x2 Teeth

18 cm
1.25 x 1 mm

No. 11025-18

\$ 63.00

Mouse Handling Forceps

Long handles make picking up small rodents easy and help prevent bites.



21 cm
Forceps with serrated silicone tips
15 x 20 mm

No. 11036-20

\$ 38.00



Replacement silicone tips
Pkg. of 2 tips

No. 11036-90

\$ 16.50

Ultra Fine Hemostat

These are the finest hemostats in our product line.



**Straight
Smooth**

12 cm
Tip width: 0.6 mm

No. 13020-12
\$ 98.50

**Curved
Smooth**

12 cm
Tip width: 0.6 mm

No. 13021-12
\$ 104.00

Fine Hemostat

**Straight
Smooth**

12 cm
Tip width: 1 mm

No. 13006-12
\$ 97.00

**Curved
Smooth**

12 cm
Tip width: 1 mm

No. 13007-12
\$ 101.50

Micro-Mosquito



Straight Serrated

12 cm
Tip width: 1 mm

No. 13010-12
\$ 86.50



Curved Serrated

12 cm
Tip width: 1 mm

No. 13011-12
\$ 90.00

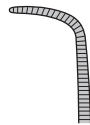

Angled 90° Serrated

12 cm
Tip width: 1 mm

No. 13012-12
\$ 92.00

Halsted-Mosquito



13108-12
13109-12



Straight Serrated

12.5 cm
Tip width: 1.1 mm

No. 13008-12
\$ 50.50

Left handed

No. 13108-12
\$ 82.50



Curved Serrated

12.5 cm
Tip width: 1.1 mm

No. 13009-12
\$ 55.50

Left handed

No. 13109-12
\$ 87.50

Crile

Kelly

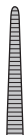

**Straight
Serrated**

14 cm
Tip width: 1.5 mm

No. 13004-14
\$ 53.00



**Curved
Serrated**

14 cm
Tip width: 1.5 mm

No. 13005-14
\$ 57.00



**Straight
Serrated**

14 cm
Tip width: 1.5 mm

No. 13018-14
\$ 50.00



**Curved
Serrated**

14 cm
Tip width: 1.5 mm

No. 13019-14
\$ 55.00

Baby-Mixer

Providence-Hospital



**Curved
Serrated**

14 cm
Tip width: 1.3 mm

No. 13013-14
\$ 78.50



**Straight
Serrated**

14 cm
Tip width: 1.5 mm

No. 13014-14
\$ 57.50



**Curved
Serrated**

14 cm
Tip width: 1.5 mm

No. 13015-14
\$ 62.00

Hartmann



Straight Serrated

10 cm
Tip width: 1 mm

No. 13002-10
\$ 56.00



Curved Serrated

10 cm
Tip width: 1 mm

No. 13003-10
\$ 61.00

Backhaus Towel Clamp



Curved Round tips

9 cm

No. 11095-09
\$ 50.50



Curved Round tips

13 cm

No. 11095-13
\$ 54.00

HEMOSTATS

Allis Clamp

Tissue and organ holding forceps.

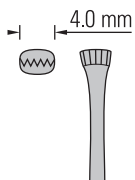

**Straight
5x6 Teeth**

15 cm
Tip width: 4 mm

No. 11091-15
\$ 93.50

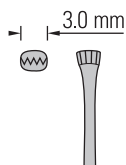

**Straight
4x5 Teeth**

12 cm
Tip width: 3 mm

No. 11092-12
\$ 85.50

Lorna Towel Clamp



**Curved
Serrated**

10 cm
Tip width: 7 mm

No. 11096-10
\$ 45.50

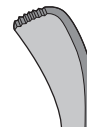

**Curved
Serrated**

13 cm
Tip width: 7 mm

No. 11096-13
\$ 46.50

Clamp Size and Clamp Pressure

Clamp pressure is determined by the closing force of the clamp (in grams), divided by the area of the vessel wall that is compressed between the jaws (in square millimeters). Thus, the smaller the vessel, the higher the pressure exerted.

Despite the wide range of closing forces, the pressure exerted by each clamp, big or small, remains consistent throughout the series. Each size of clamp exerts a pressure of 5 g/mm² when used on the largest vessel in its range, and 15 g/mm² when used on the smallest vessel. Even at the higher range, S&T's micro clamps have the gentlest working pressure of any small vessel clamp available.

Clamp (ea)	L x W (mm)	Vessel Diameter Range (mm)
00396-01 & 18040-11	3.5 x 1.0	0.4 - 1.0
00398-02 & 18040-22	5.5 x 1.5	0.6 - 1.5
00400-03 & 18040-33	7.5 x 1.75	1.0 - 2.25
00325-00	10 x 2.15	2.0 - 5.0

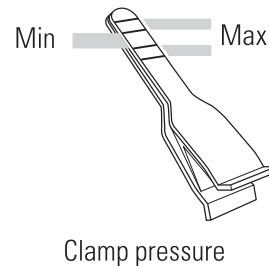
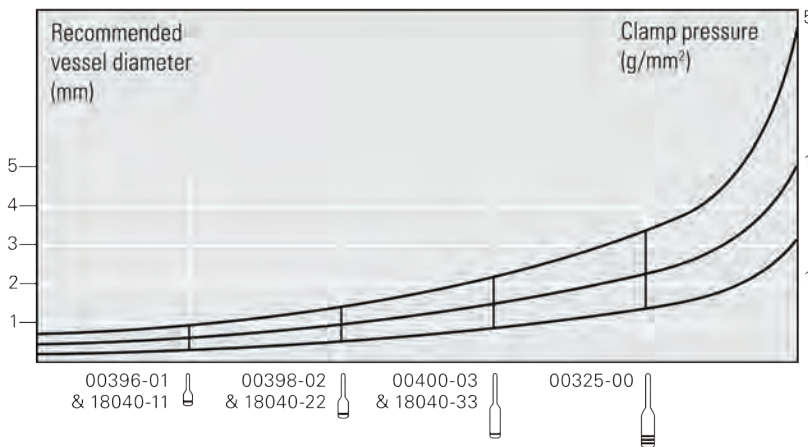

VASCULAR INSTRUMENTS

Micro Clamps



S&T B-1

No. 00396-01
\$ 177.50



S&T B-2

No. 00398-02
\$ 159.00



S&T B-3

No. 00400-03
\$ 155.50



S&T HD-S

No. 00325-00
\$ 265.50

Double Micro Clamps

For vascular approximation at anastomosis. These clamps are mounted on a 10 mm sliding bar and can easily be moved by applying gentle force. The distance between the jaws of the clamps is adjustable from 3 to 16 mm.



No. 18040-11
\$ 299.00



No. 18040-22
\$ 294.00



No. 18040-33
\$ 289.00

Micro Clamp Applying Forceps

For use with S&T vascular clamps.

S&T®

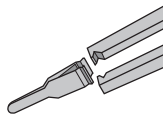

14 cm
Lock: Yes

No. 00071-14
\$ 207.00

Lock: No

No. 00072-14
\$ 155.50

Micro Clamp Applying Forceps

Compatible with S&T Clamps and Double Micro Clamps. For clamp sizes B-1, B-2, B-3, and HD-S, as well as Item Nos. 18040-11, 18040-22, and 18040-33.

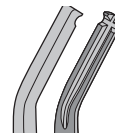

14.5 cm
Lock: No

No. 18040-14
\$ 142.00

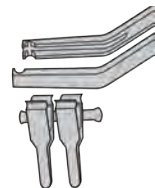

Micro Clip Applicator with Lock

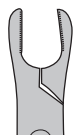

14 cm

For use with FST 18055 and 18555 series micro serrefines.

Lock: Yes

No. 18056-14
\$ 344.50

Forceps Style Clip Applicator

This applicator features special U-shaped side supports for improved seating of the clips.

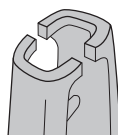

14 cm

For use with FST 18055 and 18555 series micro serrefines.

Lock: No

No. 18057-14
\$ 103.50

Biemer Clip Applicator (Forceps Style)

Application forceps for Biemer clamps made of surgical stainless steel.

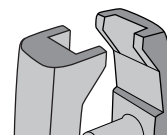

14 cm

For use with FST 18058 (Biemer Clip) series

Lock: No

No. 18059-14
\$ 93.50

VASCULAR INSTRUMENTS

CLAMPS

Stainless Steel Micro Serrefines

Used to obtain a clear surgical field for extended arterial cross-clamping.



Micro Serrefines should never be compressed with fingers; use only the appropriate applicator No. 18056-14 or No. 18057-14.

Delicate atraumatic serration
\$ 76.50



Jaw dimensions (mm)	Total length (mm)	Jaw pressure (g)	Item
10 x 2	19	60	No. 18055-01
8 x 2	16	85	No. 18055-02
6 x 1	15	100	No. 18055-03
4 x 0.75	13	125	No. 18055-04

\$ 91.50

Jaw dimensions (mm)	Total length (mm)	Jaw pressure (g)	Item
6 x 1	17	85	No. 18055-05
4 x 0.75	16	85	No. 18055-06

Titanium Micro Serrefines

Lightweight with strong clamping pressure.

Delicate atraumatic serration
\$ 160.00



Jaw dimensions (mm)	Total length (mm)	Jaw pressure (g)	Item
10 x 2	19	60	No. 18555-01
8 x 2	16	85	No. 18555-02
6 x 1	15	100	No. 18555-03
4 x 0.75	13	125	No. 18555-04

Biemer Clip

Serrated: Yes
 Straight

Closing pressure:
 0.29 - 0.39 N / 30 - 40 g



Biemer clips should never be compressed with fingers; use only the appropriate applicator No. 18059-14.

15 mm Clamping Length: 6 mm	18 mm Clamping Length: 9 mm
No. 18058-15 \$ 82.00	No. 18058-18 \$ 83.00

Bulldog Artery Spring Clamp

Can be used with a minimum of distortion for MRI investigations.



30 mm
 Serrated: Yes
 Light pressure

Straight



No. 18144-30
\$ 270.50

Moria

Moria Vessel Clamp

Straight

33 mm
 Serrated: Yes
 Light pressure
 Jaw dimensions: 13 x 1.6 mm

Moria 201/A



No. 18320-11
\$ 55.00

Moria Bulldog Type Clamps

53 mm
 Serrated: No
 Strong pressure
 Jaw dimensions: 16 x 2.5 mm

Straight

Moria MC43



No. 18374-43
\$ 144.50

Curved

Moria MC44



No. 18374-44
\$ 146.00

Dietrich Bulldog Clamps

Serrated: Yes
Closing pressure: 50 g

Straight
52.5 mm



No. 18038-45
\$ 209.00

Angled
50 mm



No. 18039-45
\$ 222.50

Bulldog Type Serrefines

Serrated: Yes



Straight
28 mm

Medium pressure



No. 18050-28
\$ 79.00

Curved
28 mm

Medium pressure



No. 18051-28
\$ 77.50



Straight

35 mm

Strong pressure

No. 18050-35
\$ 63.00



Curved

35 mm

Strong pressure

No. 18051-35
\$ 63.00

Straight

50 mm

Strong pressure

No. 18050-50
\$ 48.00

Curved

50 mm

Strong pressure

No. 18051-50
\$ 57.50

Schwartz Micro Serrefines



Serrated: No
Strong pressure
26 mm

Straight



No. 18052-01
\$ 19.00

Light bend



No. 18052-02
\$ 20.00

Sharp bend



No. 18052-03
\$ 19.50

Mini Serrefines

28 mm
Medium pressure
Serrated: Yes
Jaw dimensions: 6 x 2 mm

Straight



No. 18054-28
\$ 97.00

Curved



No. 18053-28
\$ 98.00

Horizon™ Metal Ligation System

The Horizon™ System provides surgeons with a strong, secure clip coupled with an efficient, convenient easy-load cartridge system. The preformed chevron shape of the Horizon™ Clip engulfs tissue with precise tip-to-tip closure. Heart-shaped wire is designed to give each clip a firm grip on vessels, while the triangulated cross-section of the clip leg maximizes surface-to-surface contact between clip and jaw, practically eliminating clip fallout.



Ligation Clips

1.98 x 2.87 mm
Pkg. of 6 Clips
Sterile: No

No. 18070-10
\$ 12.50



Ligation Applicator

Curved
20 cm

No. 18070-00
\$ 245.00

Clip Remover

Straight
16.5 cm

No. 18073-00
\$ 399.00

Vascular Occluders

Applications

- Fast, dependable zero-flow baseline determination in blood flow studies.
- Partial to full occlusion of vessels for circulation research studies.
- Prolonged implantations, such as chronic blood flow studies.
- Constriction of soft organs in acute or chronic applications.

Operation instruction

1. Apply the occluder cuff around the exposed blood vessel. Secure it in place with suture material through the eyelets.
2. Occlude the vessel to the desired degree by inflating the diaphragm with air or liquid injected into the actuating tube using a syringe and blunt needle. Clamp the tubing to maintain occlusion of the vessel over time.
3. To deflate, simply withdraw the air or liquid.



The actuating tube length is 90 cm and measures 0.76 mm ID x 1.6 mm OD. Detailed instructions are included.

- A: Lumen diameter
- B: Cuff width
- C: Cuff thickness

VO-1.5 N

A: 1.5 mm - B: < 3.5 mm - C: 1.5 mm

No. 18080-01
\$ 179.00

VO-2

A: 2 mm - B: 5 mm - C: 1.5 mm

No. 18080-02
\$ 179.00

VO-3

A: 3 mm - B: 5 mm - C: 1.5 mm

No. 18080-03
\$ 179.00

Benefits

- Occlusion is accomplished without traction on vessels or surrounding tissues.
- The actuating tube may be exteriorized from the occlusion site for remote actuation.
- Performance during implantations is reliable and consistent.
- Easily maintained: can be autoclaved or cold sterilized.
- Made from soft, flexible 100% silicone rubber.
- Fully operational with instant response using air, liquids, or inert gases.

Selection

The lumen diameter when deflated is usually the determining factor in the selection of the proper device. Select the occluder size that provides a slightly loose fit around the subject vessel. The cuff width and thickness will vary, depending on models and sizes.

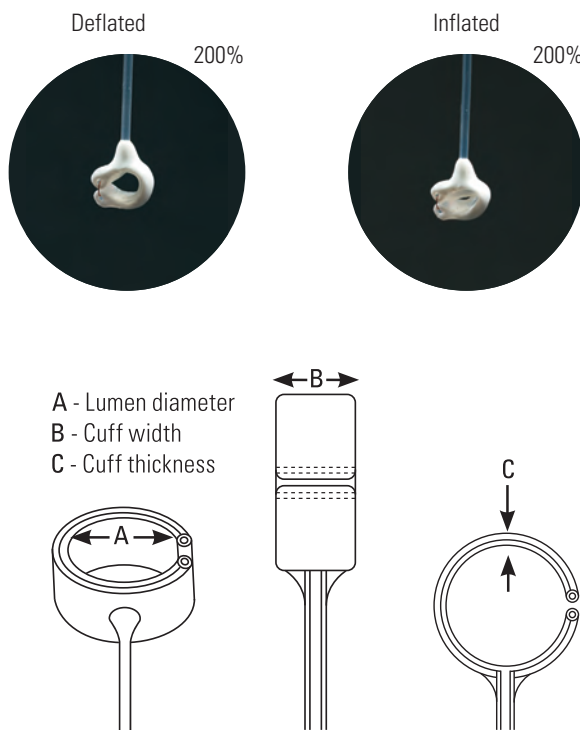

LIGATION

V-Hook

Aids in feeding fine suture around blood vessels, works very similar to ligation aids.

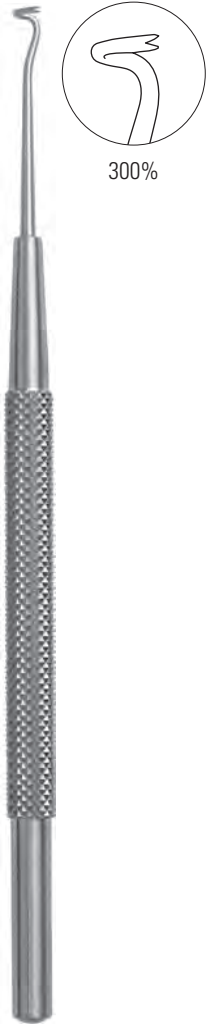

300%



11 cm

Tip Dimensions: 0.4 x 0.2 mm

No. 18052-12

\$ 107.00

Ligation Aids

A handy instrument for leading a fine suture under and around a blood vessel for tying-off purposes. Also useful for ligating peripheral nerves. Grooves toward hole help threading.



18063-13



300%



10.5 cm

Hole Ø: 0.4 mm

No. 18062-12

\$ 144.00



200%

200%



13.5 cm

Hole Ø: 1 mm

No. 18062-13

\$ 96.00

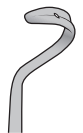

13.5 cm

Hole Ø: 1 mm

No. 18063-13

\$ 101.50

Vessel Dilators

Highly modified forceps with elongated, parallel tips which are highly polished. Designed for controlled intraluminal vessel dilation.



Angled 10°

11 cm
Tip Ø: 0.1 mm

No. 00126-11
\$ 378.00

Tip Ø: 0.2 mm

No. 00125-11
\$ 371.00



Angled 45°

13.5 cm
Tip Ø: 0.2 mm

No. 00276-13
\$ 360.00

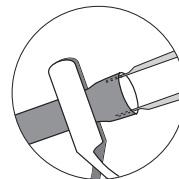

Angled 10°

12 cm
Tip Ø: 0.1 mm

No. 18131-12
\$ 224.50

Tip Ø: 0.2 mm

No. 18132-12
\$ 222.50

Micro Cannulation System

This micro cannula is most helpful for quick and easy insertion in arteries and veins. It can be used as an “indwelling” catheter during long term experiments. With care, thorough rinsing and sterilization, it can be reused several times. Detailed instructions are included.



Features

- Biocompatible Teflon® tubing.
- Cannula size 0.33 mm OD – 0.16 mm ID
- A pointed stainless steel stylus (trocar), to aid in vascular penetration and allow a maximum range of cannula manipulation during insertion.
- Contoured tip for easy insertion, fitted with shoulder for “tie-in” to prevent accidental removal.
- Female luer connection for linkage to infusion lines.

1 Approach

Cannulation Forceps (Item No. 18403-11) and Spinal Cord Hook (Item No. 10162-12) aid in the insertion process.

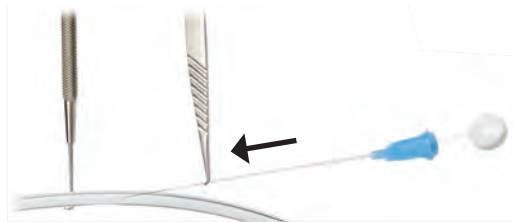

2 Insertion

Remove trocar and advance cannula.



3 Secure

Use shoulder hub and suture to “tie in” cannula to prevent accidental removal.



Instruments sold separately.

8 cm

Cannula size: 0.33 mm OD - 0.16 mm ID

No. 18000-10

\$ 47.00

Vessel Cannulation Forceps

These vessel cannulation forceps are useful whenever a fine plastic tube has to be introduced into a small blood vessel of almost equal size. The hollowed jaws hold the tubing securely without deforming it. The tip of the tubing is directed exactly into the vessel opening without damage to the vessel from unwanted movement.

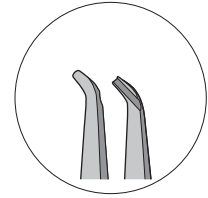

For tubing of 0.35 mm OD
11 cm

No. 00608-11
\$ 285.50

For tubing of 0.5-1 mm OD
11 cm

No. 00574-11
\$ 282.50



For tubing of 0.35 mm OD
13 cm

No. 11280-11
\$ 293.00

For tubing of 0.5 mm OD
11 cm

No. 11281-11
\$ 224.00

For tubing of 1 mm OD
11 cm

No. 11282-11
\$ 201.00



For tubing of 0.35 mm OD
11.5 cm

No. 18403-11
\$ 201.00

For tubing of 0.6 mm OD
11.5 cm

No. 18406-11
\$ 193.00

For tubing of 0.6 mm OD
13.5 cm

No. 18406-13
\$ 186.50

PROBES, NEEDLE HOLDERS, WOUND CLOSURE, RETRACTORS

Probes & Hooks 135 – 139

Spatulae 140 – 144

Spoons 145

Pins & Holders 146 – 147

Wound Closure 148 – 159

Retractors 160 – 167



Double Pronged Pick

For peritoneum, pleura, endocardium, organ capsules and skin. Grasps lifts skin, tissue and dura etc.

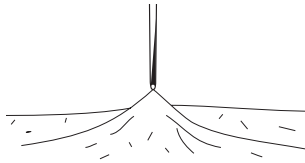
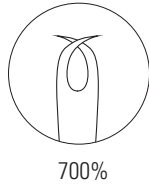

The tip consists of two very sharp, nearly horizontally opposed points. By applying gentle downward pressure and twisting slightly in a clockwise fashion, the points will embed themselves horizontally into fine membranes or skin etc., so that it may be lifted upward. This instrument also has been used successfully when separating fine tissue from an underlying area that is not to be cut.



No. 18067-11
\$ 123.00

Spinal Cord Hook

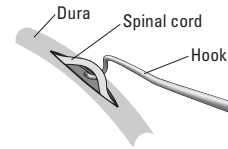
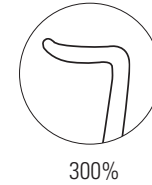

Shaped like a ligation aid and sized to isolate the spinal cord from the dura of adult mice and neonatal rats. The cord can then be cut with minimal damage to the dura.



No. 10162-12
\$ 114.50

Bonn Micro Probes

Micro Points

Actual size



Angled 45°

13.5 cm
Tip Ø: 0.025 mm

No. 10032-13

\$ 82.50

Actual size



Straight

13.5 cm
Tip Ø: 0.025 mm

No. 10030-13

\$ 83.00

Actual size



Wide Hook

13.5 cm
Tip Ø: 0.038 mm

No. 10033-13

\$ 81.50

Actual size



Narrow Hook

13.5 cm
Tip Ø: 0.025 mm

No. 10031-13

\$ 87.00

300%



Angled 90° Short

15.5 cm
Tip Ø: 0.05 mm

No. 10063-15

\$ 91.00

300%



Angled 45°

15.5 cm
Tip Ø: 0.038 mm

No. 10066-15

\$ 85.50

300%



Angled 90° Long

15.5 cm
Tip Ø: 0.02 mm

No. 10065-15

\$ 89.50



Probes and Explorers

Micro Hooks



Actual size



Angled 80° Short

15.5 cm
Tip Ø: 0.12 mm

No. 10140-04
\$ 20.50

Actual size



Straight

15.5 cm
Tip Ø: 0.25 mm

No. 10140-01
\$ 16.50

175%



Micro hook

13 cm
Tip Ø: 0.05 mm

No. 10064-14
\$ 91.00



Actual size

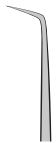

Angled 80° Long

15.5 cm
Tip Ø: 0.15 mm

No. 10140-03
\$ 18.00

Actual size



Angled 80°

15.5 cm
Tip Ø: 0.15 mm

No. 10140-02
\$ 18.50

175%



Blunt hook

12 cm
Tip Ø: 0.3 mm

No. 10062-12
\$ 77.50

175%



Sharp hook

12 cm
Tip Ø: 0.075 mm

No. 10061-12
\$ 75.50

Titanium Micro Point, Y-Hook, and Spatula

These instruments are lightweight, color coded for easy identification, have an ergonomic design and a non-reflective surface.



Micro Point

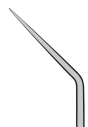

Angled 45°

12.5 cm
Tip Ø: 0.4 mm

No. 10165-11
\$ 127.00



Y-Hook



Angled 45°

12.5 cm
Tip width: 0.5 mm

No. 10166-11
\$ 120.50



Micro Spatula



Angled 30°

12.5 cm
Tip: 0.25 x 0.6 mm

No. 10167-11
\$ 108.00

Vessel Dilating Probe



Angled

12.5 cm
Tip Ø: 0.6 mm

No. 10160-13
\$ 182.50

Gross Anatomy Probe

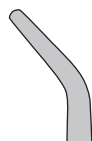

Angled 45°

15 cm
Tip Ø: 1.2 mm

No. 10088-15
\$ 19.50

Grooved Director

The Grooved Director is a specialized multipurpose device which is used by surgeons in different areas to probe cavities and wounds for example.



13 cm
with Tongue Tie

No. 10290-13
\$ 17.50

Combination Spoon and
Spatula

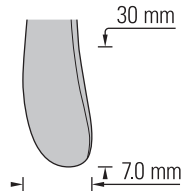
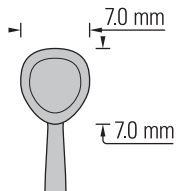

17.5 cm
Spoon: Ø 7mm / Spatula: 30 x 7mm

No. 10090-17
\$ 153.00

Combination Probe and
Spatula

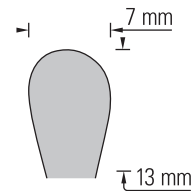

14 cm
13 x 7 x 0.6 mm
Tip Ø: 0.1 mm

No. 10090-13
\$ 155.50

Micro Spatula

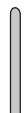

Straight

11 cm
17.5 x 1 x 0.25 mm

No. 10089-11
\$ 107.00

Mirror Finish Micro Spatula

Mirror finished to provide a non-stick spatula.



Curved

12 cm
15 x 0.8 x 0.25 mm

No. 10087-12
\$ 159.00

Double-Ended Micro Spatula

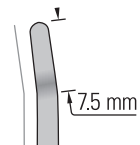

Curved/Angled

13 cm
25 x 2 x 0.3 mm

No. 10091-12
\$ 170.00

Iris Spatula



SPATULAE



Curved

12.5 cm
20 x 1.8 x 0.3 mm

No. 10092-12
\$ 102.50



Slightly curved

12.5 cm
23 x 1.8 x 0.3 mm

No. 10093-13
\$ 100.50



Straight

12.5 cm
33 x 3 x 0.3 mm

No. 10094-13
\$ 98.50

Micro Spatula Kit

Kit with 4 pieces.

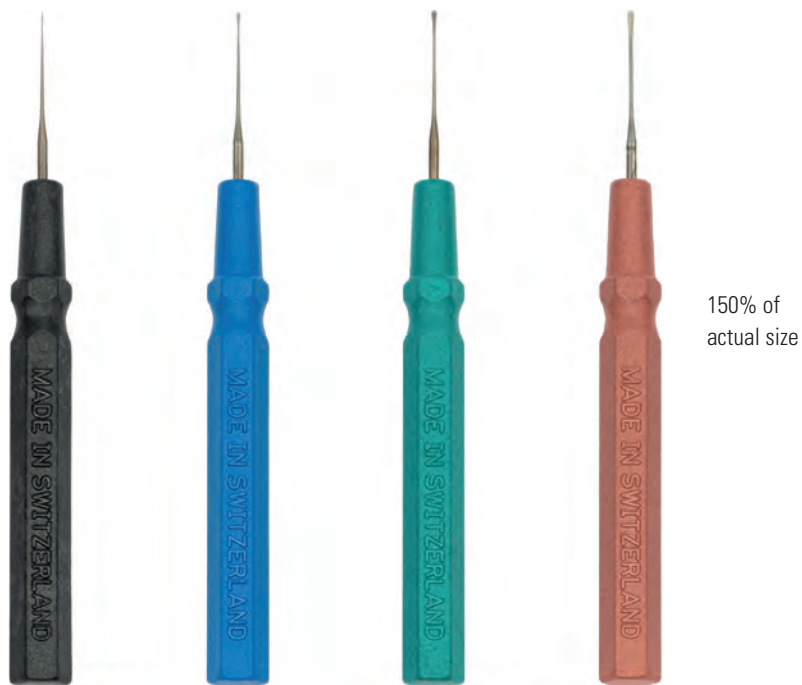

Straight

6 cm

Tip width: Black: 0.2 mm, Blue: 0.3 mm, Green: 0.5 mm, Red: 0.7 mm

No. 10098-06

\$ 26.00

SPATULAE

Mini Hippocampal Dissecting Tool

The instrument ends are malleable to allow you to adjust their shape to the correct angle for optimal positioning.

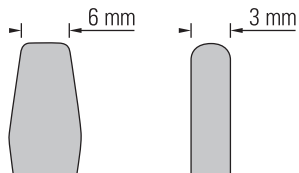

14.5 cm
20 x 6 mm & 13 x 3 mm
Tip thickness: 0.5 mm

No. 10099-12
\$ 200.00

Hippocampal Dissecting Tool

The instrument ends are malleable to allow you to adjust their shape to the correct angle for optimal positioning.

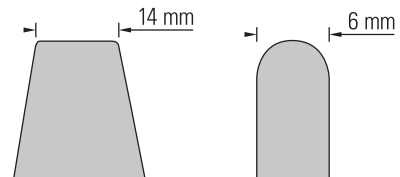

16 cm
27 x 14 mm & 27 x 6 mm
Tip thickness: 0.5 mm

No. 10099-15
\$ 98.50

Spoon

Moria



Moria 1121B



12.5 cm
Tip Ø: 8 mm
Depth: 2 mm

No. 10321-08
\$ 248.50

Mini Perforated Spoon

Most commonly used to take embryos out of solution and handling very small organs.

Moria



Moria MC 17C

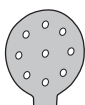

10 cm
Tip Ø: 8 mm
Depth: 1 mm
Hole Ø: 0.8 mm

No. 10370-19
\$ 220.50

Perforated Spoon

Most commonly used to take embryos out of solution and handling very small organs.



Moria



Moria MC 17 BIS

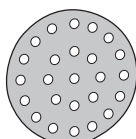

14.5 cm
Tip Ø: 15 mm
Depth: 3 mm
Hole Ø: 0.9 mm

No. 10370-18
\$ 261.50

Moria MC 17

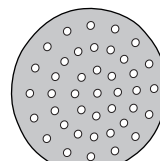

14.5 cm
Tip Ø: 20 mm
Depth: 5 mm
Hole Ø: 0.9 mm

No. 10370-17
\$ 235.50

Mirror Finish Cutting Spoon

Non stick cutting spoon.

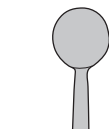

13 cm
Tip Ø: 4.5 mm
Depth: 0.15 mm

No. 10360-13
\$ 130.00

SPOONS

Pin Holder

Light weight.



17 cm

Aluminum handle with nickel-plated chuck
Jaw opening: 0 to 1 mm

No. 26018-17

\$ 27.00

Pin Holder



Moria



Moria MC1

12 cm

Nickel-plated
Jaw opening: 0 to 1 mm

No. 26016-12

\$ 47.50

Insert Pins

All insert pins fit any of our pin holders.
Pins are antimagnetic and acid resistant.

5 cm
Stainless Steel



Lancet

No. 26007-01
\$ 5.50



Straight

No. 26007-02
\$ 5.50



Curved

No. 26007-03
\$ 5.50



Lancet half

No. 26007-04
\$ 5.50



Spatula

No. 26007-05
\$ 5.50

Black Anodized Minutien Pins

These high quality pins are black for best visibility under high magnification and bright light.

Tip Ø: 0.0175 mm
Rod Ø: 0.15 mm
1.2 cm
Box of 500 pins



No. 26002-15
\$ 32.00

Stainless Steel Minutien Pins

The thinnest and finest pins available.



Tip Ø: 0.0125 mm
Rod Ø: 0.1 mm
1.2 cm
Box of 500 pins

No. 26002-10
\$ 32.00

Tip Ø: 0.0175 mm
Rod Ø: 0.15 mm
1.2 cm
Box of 500 pins

No. 26003-15
\$ 32.00

Tip Ø: 0.02 mm
Rod Ø: 0.2 mm
1.2 cm
Box of 500 pins

No. 26002-20
\$ 32.00

Black Anodized Insect Pins

Nylon heads
Tip Ø: 0.03 mm
Pkg. of 100 pins
\$ 9.50

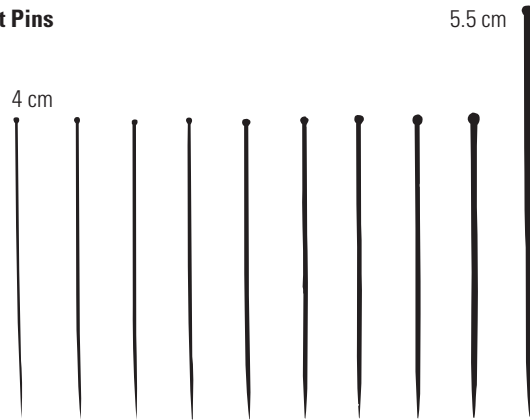

Size	000	00	0	1	2	3	4	5	6	7
Rod Ø (mm)	0.25	0.3	0.35	0.4	0.45	0.5	0.55	0.6	0.65	0.7
No. 26000	-25	-30	-35	-40	-45	-50	-55	-60	-65	-70

Stainless Steel Insect Pins

Nylon heads
Tip Ø: 0.03 mm
Pkg. of 100 pins
\$ 12.00

Size	000	00	0	1	2	3	4	5	6	7
Rod Ø (mm)	0.25	0.3	0.35	0.4	0.45	0.5	0.55	0.6	0.65	0.7
No. 26001	-25	-30	-35	-40	-45	-50	-55	-60	-65	-70

Etched Tungsten Micro Needles

These Tungsten micro needles are drawn to an approximate 1 micron tip and three different rod diameters are offered. Each provides lateral stability as well as minimal spring action during manipulation. The micro needles can be used with our pin holders shown on page 146.



Tip Ø: 1 µm
Box of 10 needles

Rod Ø (mm)	Item	Price
0.125	No. 10130-05	\$ 97.50
0.25	No. 10130-10	\$ 97.50
0.5	No. 10130-20	\$ 97.50

NEEDLE HOLDERS

Castroviejo

Micro pattern, with slightly blunted tips.



Never use a micro needle holder with needles that are too thick, as this can easily damage the fine jaws. Use only micro needles of less than 0.2 mm diameter (see page 154).



Straight

9 cm
Tip width: 0.6 mm
Lock: Yes

No. 12060-01
\$ 376.50

Tip width: 0.6 mm
Lock: No

No. 12060-02
\$ 354.00



Curved

9 cm
Tip width: 0.6 mm
Lock: Yes

No. 12061-01
\$ 391.50

Tip width: 0.6 mm
Lock: No

No. 12061-02
\$ 371.00



Curved

13.5 cm

Lock: Yes

No. 12875-13
\$ 435.00

Round-Handled Micro/Macro Needle Holder

These Round-Handled Needle Holders have a dual-purpose and can be used for microscopic and macroscopic applications. The fine tapered tips can be used to handle small needles up to 0.2 mm in diameter. While the remaining portion of the tip ensures a secure hold for larger needles. The balanced design improves control and stability, while the ergonomic handle enhances grip and reduces hand strain.

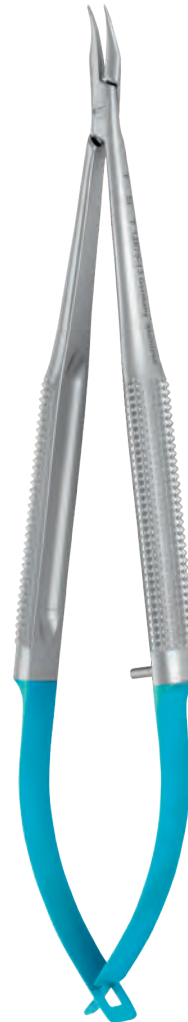

Round Handled Needle Holder

Round handles allow easy fingertip adjustments.



Straight

12.5 cm
Lock: Yes

No. 12075-12
\$ 387.50

Lock: No

No. 12076-12
\$ 352.00



Curved

12.5 cm
Lock: No

No. 12074-12
\$ 279.50

Round Handled Needle Holder with Suture Cutter

Round handles allow easy fingertip adjustments.



Actual size



Never use a micro needle holder with needles that are too thick, as this can easily damage the fine jaws. Use only micro needles of less than 0.2 mm diameter (see page 154).



Curved

14 cm
Cutting edge: 3.5 mm
Lock: No

No. 12075-14
\$ 643.00

Kalt

The Kalt needle holder is characterized by its extraordinary design and good handling. The closure system closes softly and securely and can be easily opened again with your thumb.



Straight

Serrated: Yes
13.5 cm
Lock: Yes

No. 12080-14
\$ 310.00



Curved

Serrated: Yes
13.5 cm
Lock: Yes

No. 12081-14
\$ 325.00

NEEDLE HOLDERS

Castroviejo with Tungsten Carbide Jaws

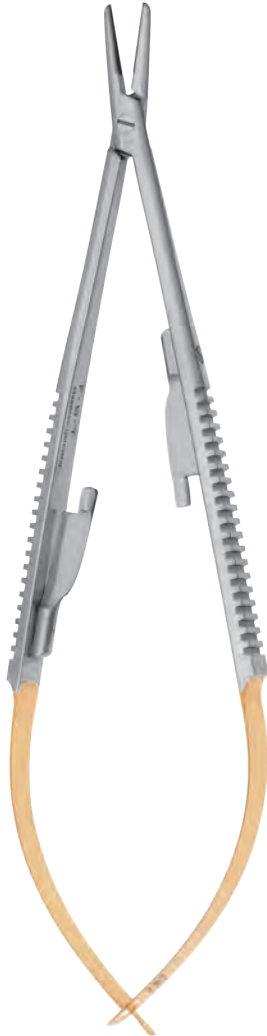

Straight

14 cm
Tungsten Carbide jaws
Lock: Yes

No. 12565-14
\$ 407.00

Mathieu

Extra slim and narrow profile, with squeeze-lock.
Facilitates excellent wrist motion for suturing.



12510-14



14 cm
Extra narrow profile
Lock: Yes

No. 12010-14
\$ 150.00



14 cm
Tungsten Carbide jaws
Lock: Yes

No. 12510-14
\$ 241.50

WOUND CLOSURE

Halsey

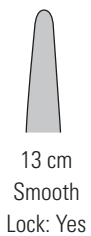
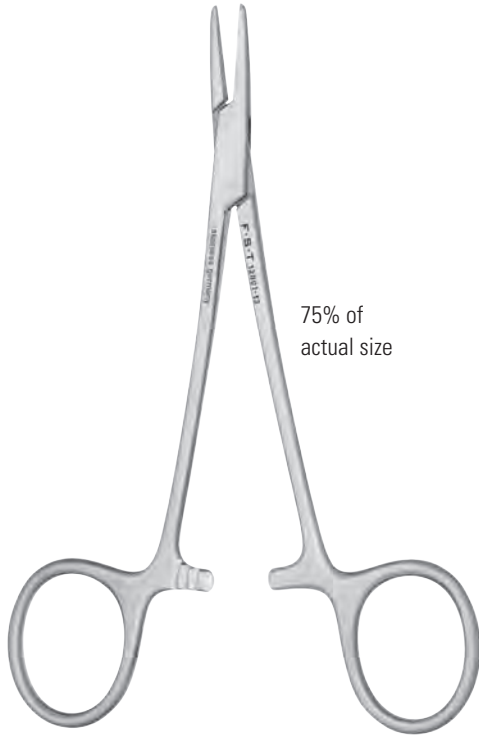

No. 12001-13
\$ 72.50

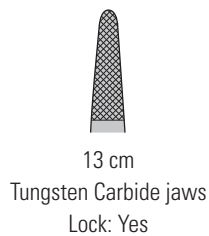

No. 12501-13
\$ 186.00

Halsey with Tungsten Carbide Jaws

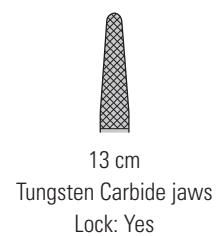

No. 12500-12
\$ 218.00

WOUND CLOSURE

NEEDLE HOLDERS

Olsen-Hegar with Suture Cutter



12102-12

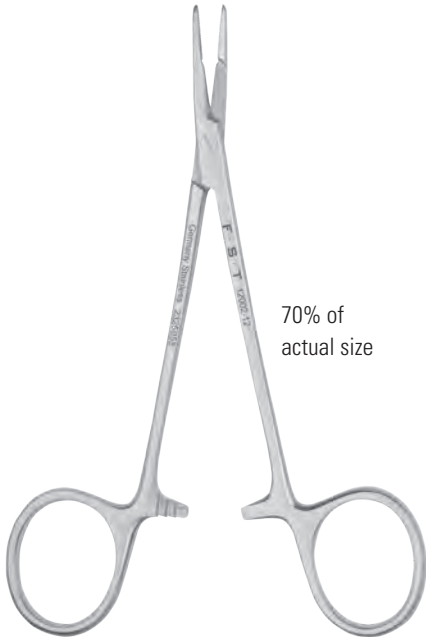

70% of actual size

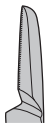

12 cm

Cutting edge: 10 mm
Lock: Yes

No. 12002-12
\$ 163.00

No. 12102-12
\$ 181.00



14 cm

Cutting edge: 15 mm
Lock: Yes

No. 12002-14
\$ 169.00

Olsen-Hegar with Suture Cutter and Tungsten Carbide Jaws



12512-12



12502-12

12512-12



70% of actual size



12 cm

Tungsten Carbide jaws
Cutting edge: 10 mm
Lock: Yes

No. 12502-12
\$ 237.50

No. 12512-12
\$ 264.50



14 cm

Tungsten Carbide jaws
Cutting edge: 15 mm
Lock: Yes

No. 12502-14
\$ 248.50

Mayo-Hegar

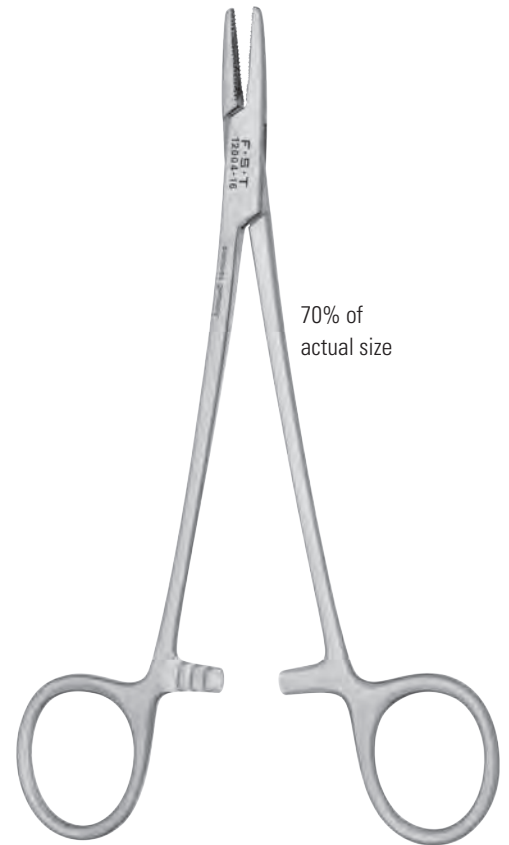

70% of actual size



16 cm

Lock: Yes

No. 12004-16
\$ 86.50

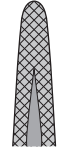

18 cm

Lock: Yes

No. 12004-18
\$ 92.50

WOUND CLOSURE

Crile-Wood



12504-15



12503-15
12504-15

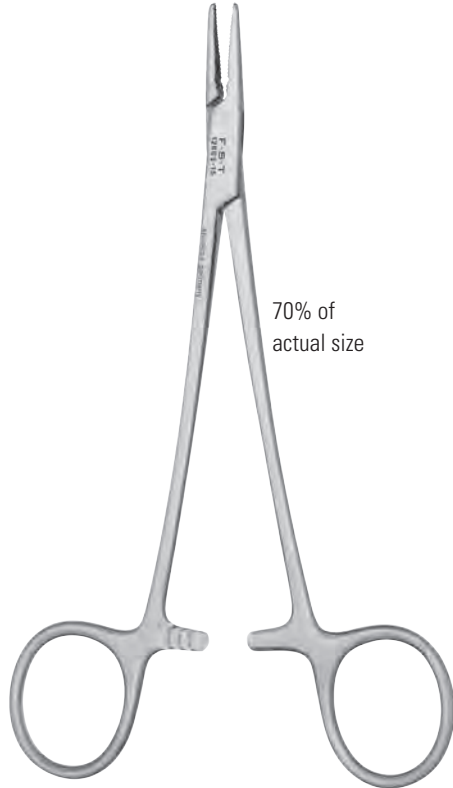

70% of actual size

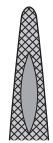

15 cm



15 cm

Tungsten Carbide jaws



15 cm

Lefthanded & Tungsten Carbide jaws

Lock: Yes

No. 12003-15
\$ 78.50

No. 12503-15
\$ 179.00

No. 12504-15
\$ 204.50

Slim Elongated Needle Holder with Tungsten Carbide Jaws

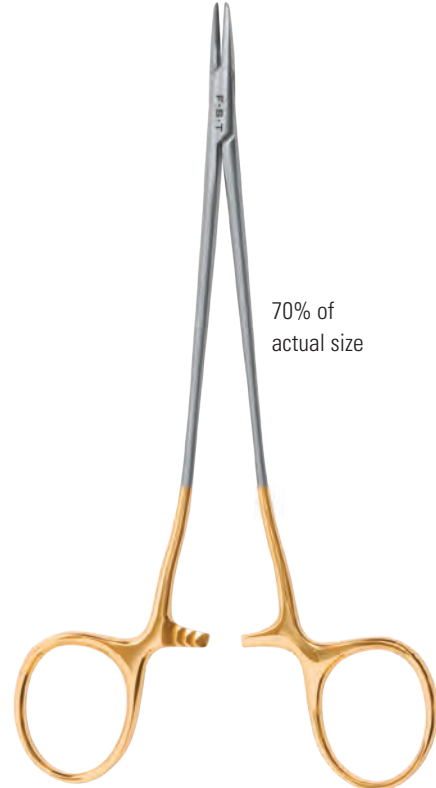

70% of actual size



15 cm

Tungsten Carbide jaws

Lock: Yes

No. 12005-15
\$ 246.50

WOUND CLOSURE

Microsurgical Needles with Suture Thread Attached

The combination of proprietary needle design technology and state-of-the-art manufacturing techniques has enabled FST to provide a microsurgical needle that is unmatched in the industry. FST microsurgical needles provide frictionless tissue penetration. They are inspected under the microscope at critical stages during the manufacturing process, and a multi-point final inspection of each suture and needle combination ensures a high quality product.

The suture-to-needle attachment is tested to higher standards than the USP specifications.

Features:

- Needle and thread combination comprising of nonabsorbable black nylon polyamide monofilament thread and stainless steel 3/8 circle needle. Nylon is suitable for closing ophthalmic, neurological and microvascular wounds.
- 3/8 circle precision taper point. Stainless steel needle honed under microscope by hand. Superfine round tip with flattened body to improve stability in needle holder. Easy penetration. Precise stitch placement.
- Grinding geometry and suture needle attachment are directed toward frictionless tissue penetration.
- Each needle suture combination is individually packed and sealed in a peel-open blister pack.

Sterile

Pkg. of 12 disposable units

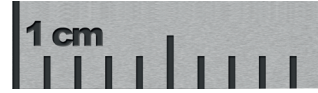
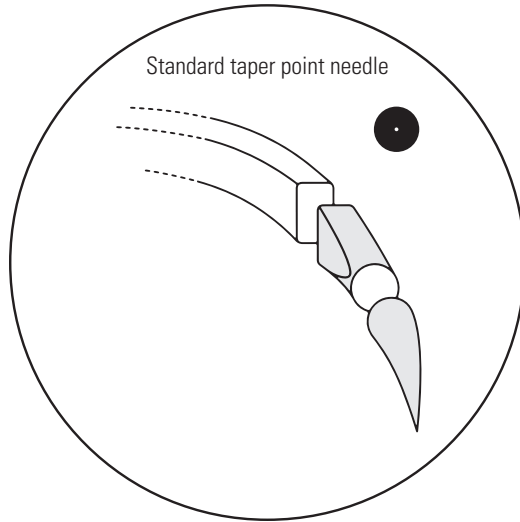

400% of actual size

No. 12052-11



No. 12052-10



No. 12052-09

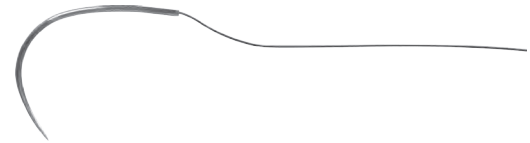

No. 12052-08



Suture size	Suture length (cm)	Needle Ø (micron)	Needle Ø (mm)	Needle chord length (mm)	Circle	Item	Price
8/0	15	140	0.14	29	3/8	No. 12052-08	\$ 80.50
9/0	15	100	0.1	24	3/8	No. 12052-09	\$ 107.00
10/0	10	70	0.07	18	3/8	No. 12052-10	\$ 169.00
11/0	10	50	0.05	16	3/8	No. 12052-11	\$ 220.00

Suture Needles

- Polished stainless steel
- 3/8 curved
- Round with standard eye
- Suitable for sutures up to 0.32 mm diameter

Ø: 0.35 mm

Sterile: No

Pkg. of 12 needles

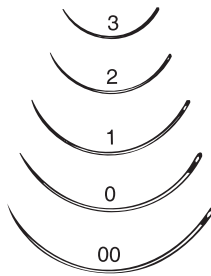

Size	Needle Chord Length (mm)	Item	Price
3	12 mm	No. 12050-03	\$ 27.50
2	16 mm	No. 12050-02	\$ 27.50
1	20 mm	No. 12050-01	\$ 27.50
0	23 mm	No. 12050-10	\$ 27.50
00	26 mm	No. 12050-20	\$ 27.50

Silk Suture

Silk suture has a smooth flow through tissue while maintaining knot security.

Braided Silk

Sterile: No

Can be ETO sterilized



Size	Suture Ø (mm)	Spool length (m)	Item	Price
7/0	0.05	91	No. 18020-70	\$ 78.50
6/0	0.08	23	No. 18020-60	\$ 34.50
5/0	0.12	23	No. 18020-50	\$ 35.00
4/0	0.17	23	No. 18020-40	\$ 35.50
3/0	0.22	23	No. 18020-30	\$ 36.50
2/0	0.32	23	No. 18020-20	\$ 45.00
0	0.37	23	No. 18020-00	\$ 47.50
1	0.45	23	No. 18020-01	\$ 51.50
2	0.55	23	No. 18020-02	\$ 69.50
3	0.65	23	No. 18020-03	\$ 60.00

For Suture Tying Forceps, see pages 100 - 102.

Nylon Monofilament Suture

Nylon is known for its uniform diameter flexibility and outstanding consistent knot security.

Nylon monofilament

Sterile: No

Can be ETO sterilized



Size	Suture Ø (mm)	Spool length (m)	Item	Price
8/0	0.04	91	No. 18030-80	\$ 94.50
7/0	0.05	91	No. 18030-70	\$ 76.50
6/0	0.07	91	No. 18030-60	\$ 88.50
5/0	0.1	91	No. 18030-50	\$ 90.50
4/0	0.15	91	No. 18030-40	\$ 91.50
3/0	0.2	91	No. 18030-30	\$ 93.50

Suturing Principles and Techniques in Laboratory Animal Surgery

This manual introduces the reader into the basic principles, materials and surgical instruments required for suturing and wound closure used on laboratory animals. It provides descriptions and pictures portraying proper tissue handling and aseptic technique, correct hand placement and use of surgical instruments, proper needle placement on needle holders, and provides an in-depth explanation of various suture patterns and associated principles for proper knot tying during wound closure.

The included DVD provides descriptive narrative and step-by-step video demonstrations for each of the suturing techniques.

For your convenience all instruments which are used for the demonstrations are listed with their FST item numbers.

WOUND CLOSURE

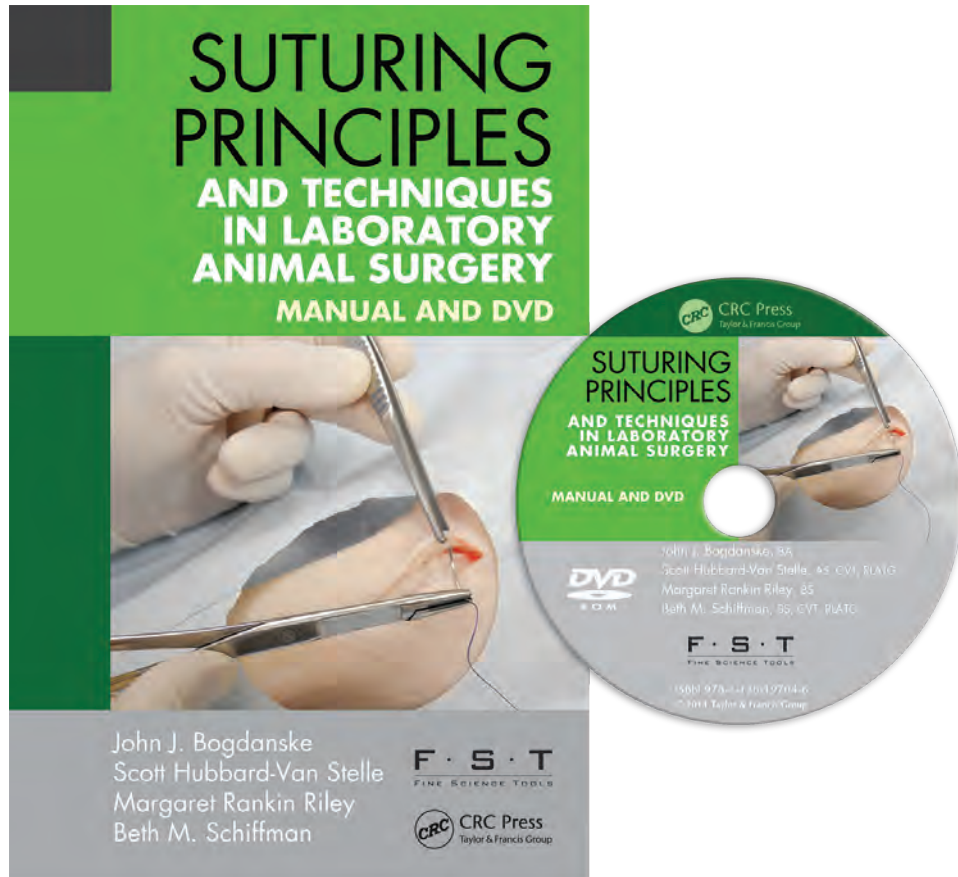

No. 23005-10

\$ 76.50

Michel Suture Clips

- Anti-magnetic
- Acid-resistant stainless steel
- Pkg. of 1,000 clips

Size (mm)	Item	Price
7.5 x 1.75	No. 12040-01	\$ 112.00
11 x 2	No. 12040-02	\$ 110.00
12 x 2.5	No. 12040-03	\$ 105.50



Applying Forceps



12.5 cm
For clip sizes 12040-02 and 12040-03

No. 12018-12
\$ 41.00

Applying and Removing Instruments



Angled
13 cm
For clip size 12040-01

No. 12029-12
\$ 158.50

Curved
13 cm
For clip sizes 12040-02 and 12040-03

No. 12028-12
\$ 116.00

WOUND CLOSURE

Reloadable Skin Stapler with Rotating Head

The 360° swivel nose and unique design offers maximum visibility at the delivery point. The stainless steel staples are non-sterile and feature a patented staple design which make for quick and easy removal. The disposable staple cartridge includes a printed staple counter.

The handle is reusable and autoclavable. Staples are non-sterile. Components sold separately or as a kit.

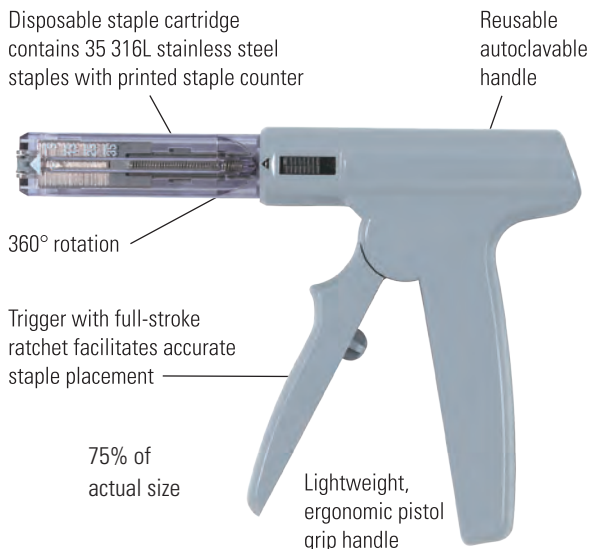

75% of actual size

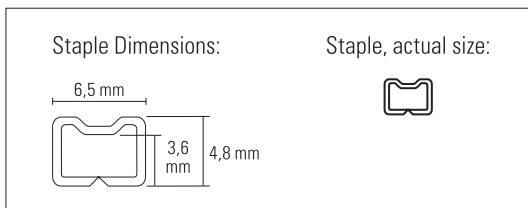

Surgical staple kit

- 1 Handle
- 1 Remover
- 12 Disposable staple cartridges

No. 12030-20

\$ 232.00

Single disposable cartridge
35 staples per cartridge

No. 12030-22

\$ 24.00

12 disposable cartridges
35 staples per cartridge

No. 12030-23

\$ 207.50

Handle

No. 12030-01

\$ 25.00

Surgical Staple Remover

Compatible with Reloadable Skin Stapler with Rotating Head and Manipler® Skin Stapler.



10 cm

No. 12030-04

\$ 9.00

Manipler® Skin Stapler

Quality, slim, lightweight design with consistent actuation and staple count indicator.

Disposable, sterile and not autoclavable.

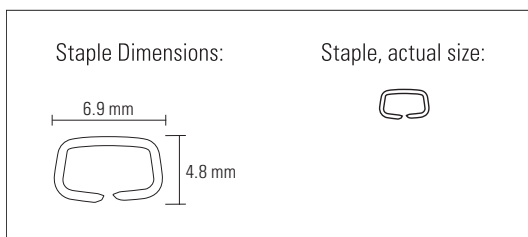

15 cm
35 staples per cartridge

No. 12035-00

\$ 18.00

AutoClip® System

The AutoClip® System is a safe, secure method of wound closure. Faster and easier than suture, this system is perfect when staples may be too thin to provide adequate closure. **Non-sterile. Components sold separately or as a kit.** We recommend using wet steam sterilization at 120-125 °C for at least 30 minutes in an autoclave to sterilize the device.

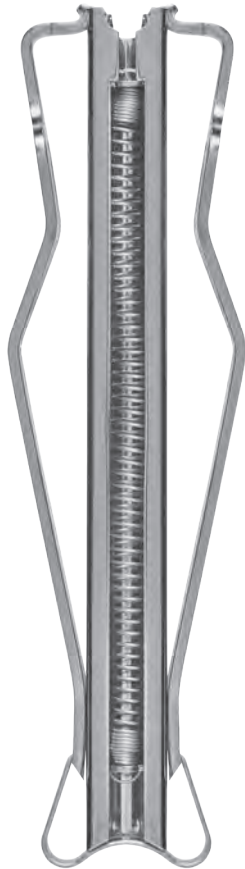

Applier



Clips



Remover

WOUND CLOSURE

AutoClip® Kit

- 1 Applier
- 9 mm clips (100)
- 1 Remover
- Storage case

AutoClip® applier

11.5 cm

AutoClip® clips

9 mm
Pkg. of 100 clips

AutoClip® clips

9 mm
Pkg. of 1,000 clips

AutoClip® remover

12.5 cm

No. 12020-00
\$ 334.50

No. 12020-09
\$ 209.50

No. 12022-09
\$ 30.00

No. 12022-19
\$ 258.00

No. 12023-00
\$ 122.50

RETRACTORS

Guthrie

Extra delicate pattern.

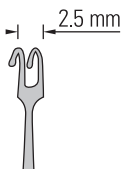

13 cm
2 Blunt

No. 17021-13
\$ 72.00

Fine Retractor

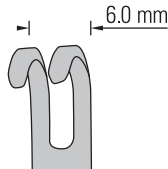

13.5 cm
2 Blunt

No. 17023-13
\$ 54.50

Blair

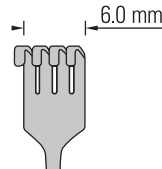

13.5 cm
4 Blunt

No. 17022-13
\$ 73.50

Fomon



80% of actual size

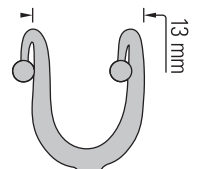

17 cm
2 with 2 mm Ball each tip

No. 17020-17
\$ 117.00

RETRACTORS

Slide Retractor with Blades

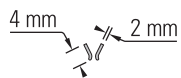

2 cm
Max. spread: 1 cm

No. 17004-03
\$ 173.50

Mini-Goldstein



2 cm
Max. spread: 0.5 cm
3 x 3 Sharp teeth

No. 17002-02
\$ 182.50

Mini-Colibri



2 cm
Max. spread: 1 cm

No. 17000-01
\$ 46.00

Slide Retractor with Teeth

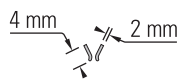

2 cm
Max. spread: 1 cm
2 x 2 Blunt teeth

No. 17005-03
\$ 173.50

Goldstein

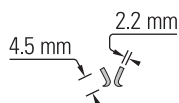

3 cm
Max. spread: 1.8 cm
3 x 3 Sharp teeth

No. 17003-03
\$ 148.00

Colibri

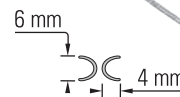

3 cm
Max. spread: 1.5 cm

No. 17000-03
\$ 43.00

4 cm
Max. spread: 1.5 cm

No. 17000-04
\$ 42.50

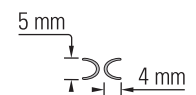

3 cm
Max. spread: 1.2 cm

No. 17000-02
\$ 42.00

Speculum

Moria

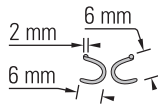

Moria 7699

4.5 cm
Max. spread: 3.5 cm
Curved

No. 17370-53

\$ 95.00

Fine Adjustable Wire Retractor

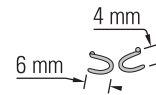

5 cm
Max. spread: 3.5 cm
Curved

No. 17004-05

\$ 208.50

Colibri

Moria

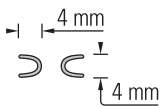

Moria 6346D

3.4 cm
Max. spread: 1.5 cm

No. 17300-02

\$ 47.00

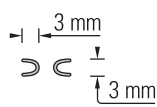

Moria 6346C

3.3 cm
Max. spread: 1.5 cm

No. 17300-03

\$ 46.00

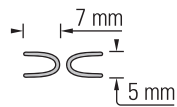

Moria 6346B

3.5 cm
Max. spread: 2 cm

No. 17300-04

\$ 48.00

Agricola

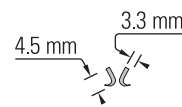

4 cm
Max. spread: 3.5 cm
3 x 3 Sharp teeth

No. 17005-04

\$ 168.50

Alm Retractor with Wire Teeth

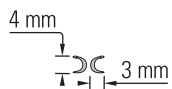

7 cm
Max. spread: 4 cm
Wire Slightly curved down

No. 17010-07
\$ 165.00

Alm Retractor with Blunt Teeth

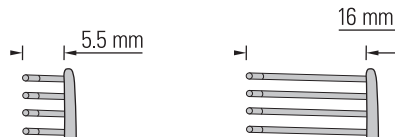

7 cm
Max. spread: 4 cm
Slightly curved
4 x 4 Blunt

No. 17008-07
\$ 155.50

7 cm
Max. spread: 4 cm
Blunt teeth
4 x 4 Blunt

No. 17009-07
\$ 173.00

Alm Retractor with Blades

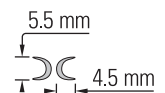

7.5 cm
Max. spread: 4.5 cm
Blades

No. 17009-08
\$ 187.50

RETRACTORS

Spring-Loaded Retractor

Curved atraumatic blades

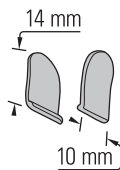

5.5 cm
Max. spread: 3 cm

14 x 10 mm

No. 17006-05
\$ 60.50

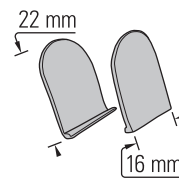

8 cm
Max. spread: 4 cm

22 x 16 mm

No. 17007-08
\$ 60.50

Heiss

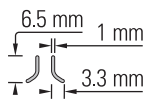

10 cm
Max. spread: 2.3 cm
4 x 4 Blunt teeth

No. 17011-10
\$ 157.00

Gelpi

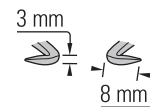

10 cm
Angled down
Max. spread: 3 cm
1 x 1 Sharp teeth

No. 17017-10
\$ 262.50

Weitlaner-Locktite

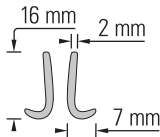

Straight
2 x 3 Blunt teeth
11 cm
Max. spread: 4 cm

No. 17012-11
\$ 222.00

Straight
3 x 4 Blunt teeth
13 cm
Max. spread: 4 cm

No. 17012-13
\$ 226.50

Wullstein

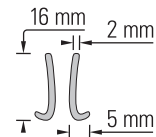
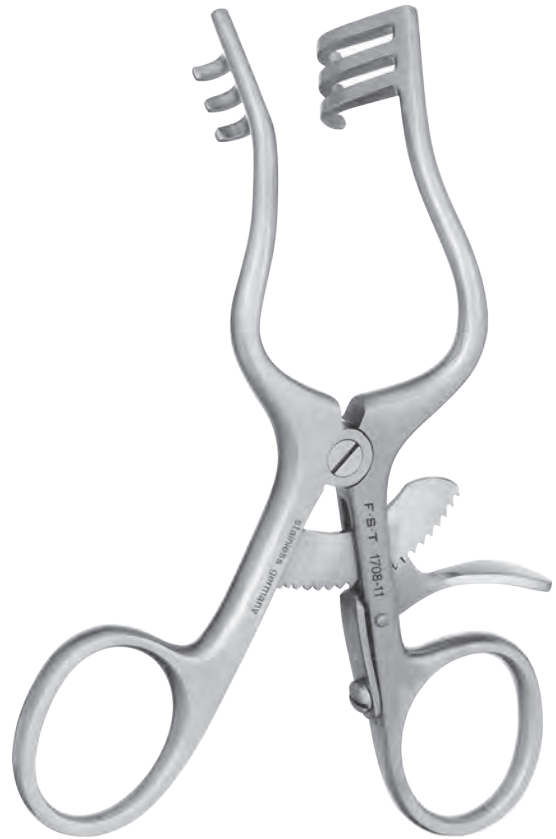

Angled down
3 x 3 Blunt teeth
11 cm
Max. spread: 3 cm

No. 17018-11
\$ 284.00

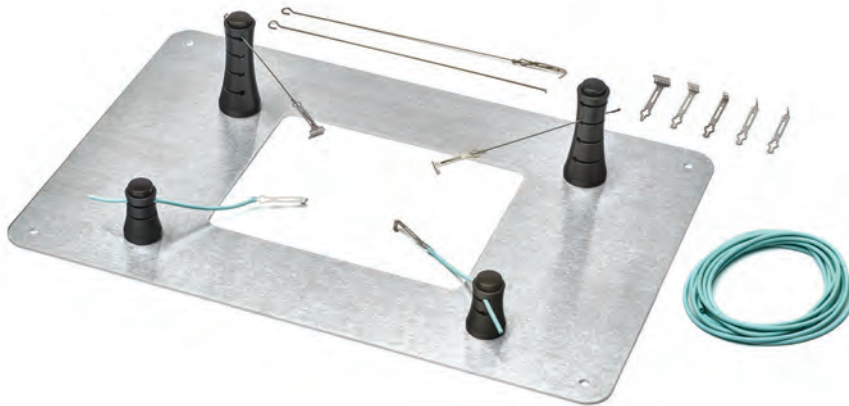

Magnetic Fixator Retraction System

This Small Animal Retraction System simplifies set-up procedure and provides the examiner with an excellent overview of the operative site. It consists of three components: Base Plate (Nos. 18200-03 & 18200-04); Fixators (Nos. 18200-01 & 18200-02); and Retractors (Nos. 18200-05 through 18200-12).

The Base Plates are made from magnetic stainless steel and are available in two sizes. The surface is nonreflective and both plates have a window in the center which allows the animal contact with body temperature control systems. The window sizes are 10 x 13 cm for the small base plate and 15 x 25 cm for the large.

The Fixators are movable anchors made from anodized aluminum with a surgical grade rare earth magnet in the base for attachment anywhere on the Base Plate. The magnets do not interfere with lab electronics and can be used in close proximity (3 cm) to ferro-magnetic items. They incorporate pushbutton-activated spring locks that grip either the Wire or Elastomer Retractors.

The Retractors are interchangeable Retractor Tips (Nos. 18200-08 through 18200-12) which attach to either Retractor Wire (Nos. 18200-05 & 18200-06) for static retraction or to Elastomer (No. 18200-07) for dynamic retraction. The Retractor Tips are light and atraumatic to delicate tissue or membrane.

All system components are autoclavable.

Kit for animals up to 200 g

Includes:

- 1 Small base plate (No. 18200-03)
- 2 Short fixators (No. 18200-01)
- 1 Tall fixator (No. 18200-02)
- 1 Elastomer, 2 m roll (No. 18200-07)
- 1 Package of retractors, blunt, 1 mm wide (No. 18200-09)
- 1 Package of retractors, blunt, 2.5 mm wide (No. 18200-10)

No substitutions



No. 18200-20
\$ 451.00

Kit for animals from 200 g up to 5 kg

Includes:

- 1 Large base plate (No. 18200-04)
- 2 Short fixators (No. 18200-01)
- 2 Tall fixators (No. 18200-02)
- 1 Elastomer, 2 m roll (No. 18200-07)
- 1 Package of retractors, blunt, 2.5 mm wide (No. 18200-10)
- 1 Package of retractors, blunt, 5 mm wide (No. 18200-11)

No substitutions

No. 18200-50
\$ 536.00

Individual parts:

Short fixator, 3 cm high
Each

No. 18200-01
\$ 109.50

Tall fixator, 6 cm high
Each

No. 18200-02
\$ 115.50

Small base plate, 20 x 30 cm
Each

No. 18200-03
\$ 84.00

Large base plate, 25 x 35 cm
Each

No. 18200-04
\$ 98.50

Wire handles, 10 cm long
Pkg. of 10

No. 18200-05
\$ 57.00

Wire handles, 14 cm long
Pkg. of 10

No. 18200-06
\$ 60.00

Elastomer, 2 m roll

No. 18200-07
\$ 26.50

Sharp retractors, 1 mm wide
Pkg. of 10

No. 18200-08
\$ 86.50

Blunt retractors, 1 mm wide
Pkg. of 10

No. 18200-09
\$ 86.00

Blunt retractors, 2.5 mm wide
Pkg. of 10

No. 18200-10
\$ 86.50

Blunt retractors, 5 mm wide
Pkg. of 10

No. 18200-11
\$ 87.00

Blunt retractors, 7.5 mm wide
Pkg. of 10

No. 18200-12
\$ 87.50

ACCESSORIES & INSTRUMENT CARE

Animal Accessories 169 – 174

Instrument Care & Accessories 175 – 186

Surgical Accessories 187 – 190

Laboratory Accessories 191 – 203



Reusable Gavage Feeding Needles

Stainless steel feeding needles with luer lock hub. Also ideal for transcatheter perfusions with a fixative. The needles come with a round tip.



Round tip

No. 18061-24



Round tip

No. 18061-50

Gauge	Length (mm)	Tip Ø (mm)	Shape	Mice (g)	Rats (g)	Guinea pigs (g)	Item	Price
24	25	1.25	Straight	>14			No. 18061-24	\$ 61.50
22	25	1.25	Straight	15-20			No. 18061-22	\$ 61.50
20	38	2.25	Straight	20-25	50-75		No. 18064-20	\$ 61.50
20	38	2.25	Curved	20-25	50-75		No. 18065-20	\$ 61.50
18	38	2.25	Straight	20-30	100-200	250-300	No. 18061-38	\$ 61.50
18	50	2.25	Curved	25-30	100-200	250-300	No. 18061-50	\$ 61.50
16	75	3	Curved		150-300	350-450	No. 18061-75	\$ 61.50
16	100	3	Curved		150-300	350-450	No. 18061-10	\$ 61.50



These needles come with a barrel tip.



No. 18060-20

Gauge	Length (mm)	Tip Ø (mm)	Shape	Mice (g)	Rats (g)	Guinea pigs (g)	Item	Price
24	25	1.7	Straight	>14			No. 18060-24	\$ 36.00
22	25	1.7	Straight	15-20			No. 18060-22	\$ 36.00
20	30	1.7	Straight	20-25	50-75		No. 18060-20	\$ 36.00
20	38	1.7	Straight	20-25	50-75		No. 18063-20	\$ 36.00
20	38	1.7	Curved	20-25	50-75		No. 18067-20	\$ 38.50
18	38	1.7	Straight	20-30	100-200	250-300	No. 18060-18	\$ 36.00
18	50	2	Curved	25-30	100-200	250-300	No. 18067-50	\$ 38.50
16	75	2.4	Curved		150-300	350-450	No. 18067-75	\$ 38.50
16	100	2.4	Curved		150-300	350-450	No. 18067-10	\$ 38.50

Single Use Gavage Feeding Needles

These economical feeding needles feature plastic luer hubs with silicone tips. They are nontoxic and nonpyrogenic. Needles can be easily formed to any desired shape. **Sterile.**

Pkg. of 5 needles



No. 18061-20

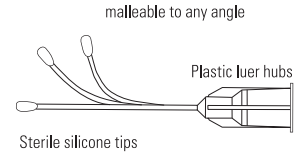

Gauge	Length (mm)	Tip Ø (mm)	Mice (g)	Rats (g)	Guinea pigs (g)	Item	Price
20	38	1.75	20-25	50-75		No. 18061-20	\$ 32.00
18	50	2.5	25-30	100-200		No. 18061-18	\$ 32.00
15	75	3		200-350	400-600	No. 18061-15	\$ 32.00

Disposable Flexible PTFE Feeding Needles

These affordable needles feature flexible PTFE tube with silicone tip and plastic luer hub, delivered in sterile pouches. They are very flexible, and translucent for easy confirmation of reagent delivery. The soft silicone tips are non-toxic and non-pyrogenic and ensure that no damage occurs during the insertion. **Sterile.**

Pkg. of 5 needles



No. 18961-85

No. 18961-75

No. 18961-15

No. 18961-17

No. 18961-18

No. 18961-20

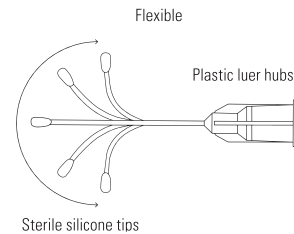

Gauge	Length (mm)	Tip Ø (mm)	Mice (g)	Rats (g)	Guinea pigs (g)	Item	Price
20	38	1.8	20-25	50-75		No. 18961-20	\$ 32.00
18	38	2	20-30	100-200	250-300	No. 18961-18	\$ 32.00
17	52	2.4	25-30	100-200	250-300	No. 18961-17	\$ 32.00
15	78	2.6		200-350	400-600	No. 18961-15	\$ 32.00
18	75	2	25-30	150-250	250-300	No. 18961-75	\$ 32.00
17	85	2.4	25-30	150-250	250-300	No. 18961-85	\$ 24.00

GenoPunch

The interchangeable GenoPunch aids in the fast and simple collection of the 2 mm tissue sample for DNA analysis and/or genotyping. FST Exclusive Item. **Autoclavable.**



**Microtubes
not included.**

GenoPunch includes

- 1 GenoPunch
- 1 0.5 ml tube holder
- 1 1.6 ml tube holder
- 1 Screwdriver
- 4 Screws

FST does not supply microtubes.



11.5 cm
Stainless Steel and
anodized aluminum
Punch Ø: 2 mm

No. 24215-02
\$ 130.00

Blue Ear Punch

The Ear Puncher relieves stress on the wrist during ID marking as it requires only a very gentle pressure to cut a hole. The stainless steel puncher has a sloped edge that provides a cut rather than a punch, which minimizes discomfort. The ear puncher should be lubricated to improve longevity. **Autoclavable.**



14 cm
Punch Ø: 1 mm

No. 24916-01
\$ 265.00

14 cm
Punch Ø: 2 mm

No. 24916-02
\$ 240.00

EAR PUNCHES

Ear Punch with Replaceable Tip

Designed to ensure a fast and clean punch, this ear punch is lightweight and fits comfortably in the palm of your hand. The tip is replaceable. **Autoclavable.**



Handle and Tip

11.5 cm
Anodized aluminum handle
and stainless steel tip
Punch Ø: 2 mm

No. 24213-02
\$ 109.00

Replacement Tip

Punch Ø: 2 mm

No. 24213-12
\$ 64.00

Ear Punch

Designed to ensure a fast and clean punch, this ear punch is lightweight and fits comfortably in the palm of your hand. **Autoclavable.**



11.5 cm
Stainless Steel and Anodized
Aluminum
Punch Ø: 2 mm

No. 24214-02
\$ 99.50

Finger Loop Ear Punch

This ear punch provides stability and control for researchers using the numbering system. The 1 mm ear punch offers greater numbering variations and/or patterns.



10.5 cm
Punch Ø: 2 mm

No. 24212-02
\$ 41.50

Punch Ø: 1 mm

No. 24212-01
\$ 43.00

Marking Pen

The Marking Pen was developed for easy, long lasting identification of laboratory animals. The markers contain no harmful chemicals and instead nontoxic pigment approved by the Japanese Ministry of Health for use in food, drugs and cosmetics. It is intended for use on the fur and not the skin and will last for 6-12 weeks.



CAUTION: Color can stain skin and clothing. The use of gloves and lab coats is recommended. These colors will not work on black fur.



Black	Blue	Green	Red	Yellow	Orange
Fine Tip 4.5 x 7.5 mm 10 ml	Fine Tip 4.5 x 7.5 mm 10 ml	Fine Tip 4.5 x 7.5 mm 10 ml	Fine Tip 4.5 x 7.5 mm 10 ml	Fine Tip 4.5 x 7.5 mm 10 ml	Fine Tip 4.5 x 7.5 mm 10 ml
No. 24202-06 \$ 72.00	No. 24202-02 \$ 72.00	No. 24202-01 \$ 72.00	No. 24202-04 \$ 72.00	No. 24202-03 \$ 72.00	No. 24202-05 \$ 72.00



Black	Blue	Green	Red	Yellow	Orange
Standard Tip 15 x 10 x 10 mm 15 ml	Standard Tip 15 x 10 x 10 mm 15 ml	Standard Tip 15 x 10 x 10 mm 15 ml	Standard Tip 15 x 10 x 10 mm 15 ml	Standard Tip 15 x 10 x 10 mm 15 ml	Standard Tip 15 x 10 x 10 mm 15 ml
No. 24202-16 \$ 72.00	No. 24202-12 \$ 72.00	No. 24202-11 \$ 72.00	No. 24202-14 \$ 72.00	No. 24202-13 \$ 72.00	No. 24202-15 \$ 72.00

Surgical Skin Marker

This marker features a versatile tip for precise fine (0.2 mm) line marking, or when held at an angle, a broad (2 mm) line marking. The marker's violet ink is nontoxic, non-tattooing and surgical prep-resistant. Markings can be removed from the skin with isopropyl alcohol. A six-inch ruler calibrated in both centimeters and inches is included.



No. 18000-30
\$ 3.00

50% of actual size

Self Piercing Ear Tags

Ideal for use in small animals such as mice and rats, these ear tags come numbered from 1-100 or 1-500. Silver colored tags with black numbers provide high visibility making them easy to read. Once applied, tags seal and cannot be removed, providing an easy to use, permanent identification method. These ear tags are safe for use in salt water.



80% of actual size



Applicator
14 cm

No. 24220-00

\$ 66.00

Custom alphanumeric sequences and numbers above 1000 are available by special order.

Customized ear tags available in packages of 100 or 500. The following markings are possible: 1 to 6 numbers only or 1 to 6 letters and numbers.

For special order, use item No. 70000-10 and indicate sequence. Please allow 4 to 5 weeks for delivery.



Picture similar

Alloy: Monel
0.8 cm
No. 1-100
Ear tags - #s 1 to 100

No. 24221-10
\$ 34.50

Alloy: Monel
0.8 cm
No. 1-500
Ear tags - #s 1 to 500

No. 24221-50
\$ 138.00

Alloy: Monel
0.8 cm
No. 501-1000
Ear tags - #s 501 to 1000

No. 24221-90
\$ 138.00

Fine Forceps Repair Kit

Realign and repair fine forceps with this convenient kit. Bent forcep tips can be restraightened with the chain nose pliers. The sharpening stone has two grooves, 1.6 mm and 0.8 mm, to assist in reshaping the forcep tips. O-rings clamp the forceps shut to ensure that both shanks are equally aligned and sharpened. Instrument oil assists in producing a smooth sharp edge. Detailed instructions are included.



Kit includes:

- 1 Sharpening stone for fine forceps (No. 29008-22)
- Ten O-rings (11200-00)
- 1 Instrument oil, 50 ml bottle (No. 29055-00)
- 1 Chain nose pliers

No. 29000-00
\$ 105.00



O-Rings for Forceps

These rubber O-rings fit our forceps and keep them closed with variable degrees of pressure on the tips.

Pkg. of 10

No. 11200-00
\$ 2.00



Instrument Oil

Physiologically inert oil for lubricating surgical instruments, box locks, ratchets and any overlapping joints.

50 ml bottle

No. 29055-00
\$ 16.50

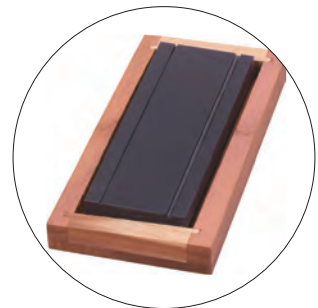

Sharpening Stone for Fine Forceps

This natural Arkansas stone assists in reshaping the tips of fine forceps. The stone has two grooves, 0.8 mm and 1.6 mm and comes in a cedar box with ten O-rings.

12.5 x 6.5 x 3 cm

No. 29008-22
\$ 61.50

Instrument Marking Tape

Organize instruments quickly and easily with this economical, non-toxic, pressure sensitive tape. Color is unaffected by boiling, cold sterilization or autoclaving. 8 colors available. **Autoclavable.**



Color	Roll length (cm)	Tape width (cm)	Material	Item	Price
Green	290	0.6	Vinyl	No. 29071-01	\$ 11.00
Blue	290	0.6	Vinyl	No. 29071-02	\$ 11.00
Yellow	290	0.6	Vinyl	No. 29071-03	\$ 11.00
Red	290	0.6	Vinyl	No. 29071-04	\$ 11.00
White	290	0.6	Vinyl	No. 29071-05	\$ 11.00
Black	290	0.6	Vinyl	No. 29071-06	\$ 11.00
Orange	290	0.6	Vinyl	No. 29071-08	\$ 11.00
Purple	290	0.6	Vinyl	No. 29071-09	\$ 11.00

**Instrument Marking Tape
7 assorted colors**

Organize instruments quickly and easily with this economical, non-toxic, pressure sensitive tape. Color is unaffected by boiling, cold sterilization or autoclaving. Includes 7 assorted color rolls: Yellow, Red, Black, White, Green, Blue and Orange. **Autoclavable.**

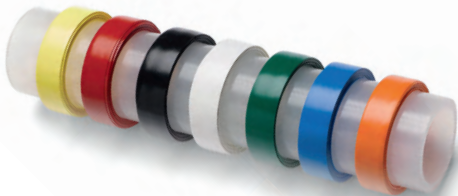

	107	0.6	Vinyl	No. 29080-02	\$ 28.00
--	-----	-----	-------	---------------------	-----------------

Instrument Marking Tape

Organize instruments quickly and easily with this economical, non-toxic, pressure sensitive tape. Color is unaffected by boiling, cold sterilization or autoclaving. 9 colors available. **Autoclavable.**



Color	Roll length (cm)	Tape width (cm)	Material	Item	Price
Green	510	0.6	Vinyl	No. 29070-01	\$ 11.50
Blue	510	0.6	Vinyl	No. 29070-02	\$ 11.50
Yellow	510	0.6	Vinyl	No. 29070-03	\$ 11.50
Red	510	0.6	Vinyl	No. 29070-04	\$ 11.50
White	510	0.6	Vinyl	No. 29070-05	\$ 11.50
Black	510	0.6	Vinyl	No. 29070-06	\$ 11.50
Brown	510	0.6	Vinyl	No. 29070-07	\$ 11.50
Orange	510	0.6	Vinyl	No. 29070-08	\$ 11.50
Purple	510	0.6	Vinyl	No. 29070-09	\$ 11.50

INSTRUMENT CARE & ACCESSORIES

Self Sealing Sterilization Pouches

Preformed pouches with self adhering tape are blue tinted on one side for visualization of contents and paper-backed on the other side. Pouches will work with either steam autoclave or ethylene oxide sterilization.

Material properties:

- Protects instruments during sterilization.
- Provides sterile storage until use.
- Write on pouches for easier identification during sterilization.



10 x 18 cm

For instruments up to 13 cm long

Pkg. of 100 pouches

No. 28000-07

\$ 46.00

13 x 26 cm

For instruments up to 23 cm long

Pkg. of 100 pouches

No. 28000-10

\$ 58.00

18 x 30 cm

For instruments up to 26 cm long

Pkg. of 100 pouches

No. 28000-12

\$ 68.00

HOT BEAD STERILIZERS

Hot Bead Sterilizer with Glass Beads

The sterilizer provides a safe, effective and convenient method for sterilizing your surgical instruments prior to and during surgery or tissue culture. Without using potentially dangerous gases flames or chemicals, you can ensure that your instruments will be free of pathogens and microbial contaminants.

The beads take 15–20 minutes to reach 240 °C to 270 °C (464 °F to 518 °F), then the sterilizer is ready for use. The temperature is thermostatically maintained and the unit can be left on all day. Instruments require approximately 20 seconds of contact with the beads for complete sterilization. The sterilizer is safe to use even in laminar flow hoods.

Sterilization test results conducted by the Pasteur Institute in Lille, France, are available upon request. Available in 110 V and 220 V. CE Certified and UL Approved.

Sterilizer includes:

- Sterilizer unit
- 1 Bag of glass beads
- 1 Dust cover for well
- 1 Small heat-tempered glass dish for small objects (only with FST 250)

FST 250 shown.
Instruments not included.

60 % of actual size



FST 250 Sterilizer

Well Ø: 4 cm
Well depth: 8 cm
Well volume: 100 ml
Total unit size: 14.5 x 12.5 x 13.5

No. 18000-45

\$ 601.00

Replacement glass beads for FST 250

Weight: 150 g

No. 18000-46

\$ 38.50

FST 350 Sterilizer

Well Ø: 4 cm
Well depth: 14 cm
Well volume: 175 ml
Total unit size: 20.5 x 12.5 x 13.5

No. 18000-50

\$ 789.00

Replacement glass beads for FST 350

Weight: 300 g

No. 18000-51

\$ 51.50

Micro Bead Sterilizer with Glass Beads

Micro Bead Sterilizer is ideal for the sterilization of small and large research tools (forceps, scissors, etc.). When the chamber is filled with the included glass beads, high temperatures (up to 300 °C / 572 °F) can be used to eliminate the presence of bacteria, spores and other micro-organisms.

Small Sterilizer 110 V

Well Ø: 4 cm
Well depth: 8 cm
Well volume: 100 ml
Total unit size: 14.5 x 15.5 x 15.5 cm

No. 18090-45**\$ 549.00****Small Sterilizer 220 V**

Well Ø: 4 cm
Well depth: 8 cm
Well volume: 100 ml
Total unit size: 14.5 x 15.5 x 15.5 cm

No. 18090-46**\$ 549.00****Replacement glass beads for small sterilizer**

Weight: 150 g

No. 18000-47**\$ 25.00****Tall Sterilizer 220 V**

Well Ø: 4 cm
Well depth: 14 cm
Well volume: 175 ml
Total unit size: 14.5 x 15.5 x 21.5 cm

No. 18090-51**\$ 599.00****Tall Sterilizer 110 V**

Well Ø: 4 cm
Well depth: 14 cm
Well volume: 175 ml
Total unit size: 14.5 x 15.5 x 21.5 cm

No. 18090-50**\$ 614.00****Replacement glass beads for tall sterilizer**

Weight: 300 g

No. 18000-52**\$ 51.50**

Small sterilizer shown.
Instruments not included.

60 % of actual size



Autoclave Tape

Tape will permanently indicate diagonal stripes after exposure to steam autoclave temperature between 121 °C and 130 °C during a 40-60 minute time period. Use with sterilization pouches, sterilization wraps and sterilization cases.

The tape can be used in:

- Gravity sterilizers operating at 121 °C (+3 °C) for 30 minutes or
- Pre-vacuum sterilizers operating at 132 °C (+3 °C) for 4 minutes and 135 °C (+3 °C) for 3 minutes
- Shelf life/durability is 36 months

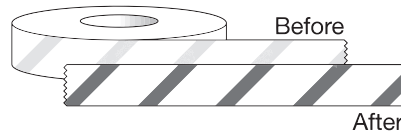

1,90 cm x 55 m

No. 28001-02

\$ 12.00

Disposable Sterilization Wraps

These biodegradable cellulose fiber wraps are resistant to tears and conform easily to maintain a breathable yet impervious barrier to airborne bacteria, saline, blood and water. Wrapping your instrument case securely will ensure the sterility of your instruments until ready for use. Available in two sizes.

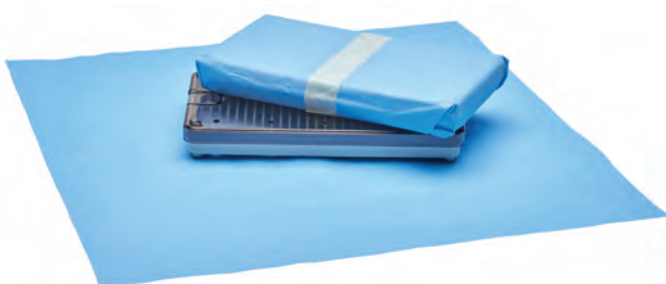

Cases not included.

38 x 38 cm
Pkg. of 25 wraps

No. 28015-15

\$ 8.00

51 x 51 cm
Pkg. of 25 wraps

No. 28020-20

\$ 11.50

Silicone Mat

High quality, extra soft mat for safe and secure placement of delicate instruments. This mat can easily be cut along the premarked grooves to fit in various sized instrument cases. **Autoclavable.**

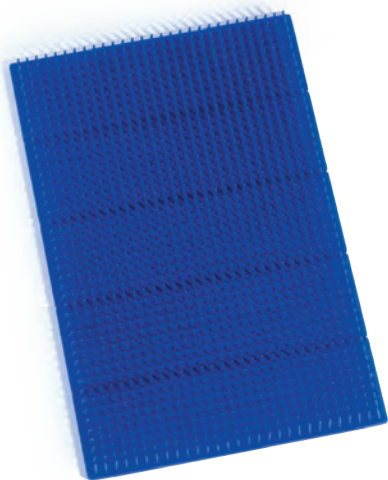

30 x 20 cm

No. 20325-00**\$ 129.50****Magnetic Sterilization Mat**

Used during sterilization and for safe anti-slip placement around surgical settings. **Autoclavable.**



Instruments not included.

30 x 20 cm

No. 20350-00**\$ 161.00****Silicone Mat**

Large, economical silicone mat. **Autoclavable.**

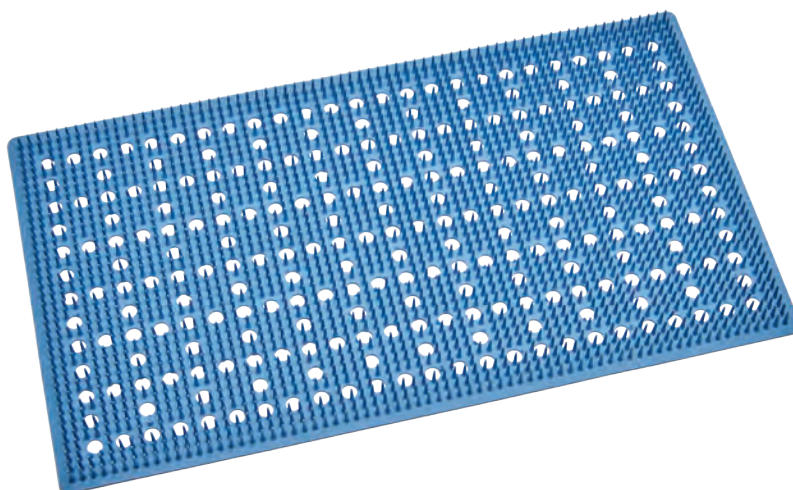

46 x 25 cm

No. 20325-10**\$ 89.00**

Sterilization Container

This plastic sterilization container includes a silicone mat for safe placement of instruments. Perforated top is clear for visual identification of instruments. **Suitable for autoclave or ethylene oxide sterilization.**



19 x 10 x 2 cm

No. 20810-01

\$ 154.50

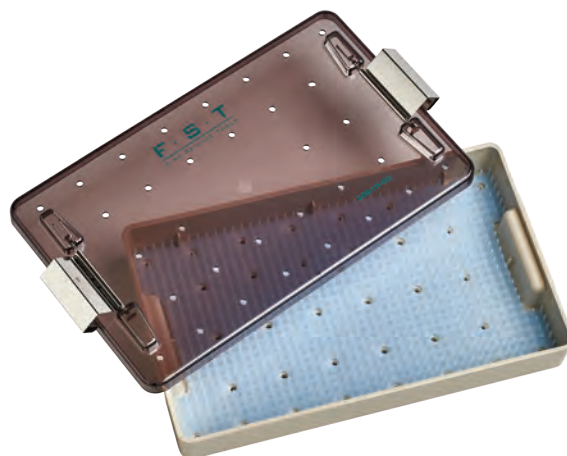

27 x 16 x 4 cm

No. 20810-02

\$ 207.00

Dual Clasping Stainless Steel Sterilization Container

This container will assist in the sterilization and storage of your fine surgical instruments. It comes with a custom fit silicone mat to keep instruments in place while the sterilizing process and storage. The textile filters are necessary for keeping instruments sterile while they remain in the container.

Suitable for autoclave or ethylene oxide sterilization.



30 x 14 x 4 cm

No. 20850-00

\$ 313.00

5 Long-term textile filters

No. 20850-10

\$ 46.00

1 Long-term textile filter

No. 20850-11

\$ 10.00

INSTRUMENT CARE & ACCESSORIES

Sterilization Container

This sterilization container is made from Ultem® polymer to ensure strength and long lasting durability. The transparent perforated lid provides easy identification of your surgical instruments. Silicone mat is included for a safe and secure hold. Trays are also stackable for convenience. **Suitable for autoclave or ethylene oxide sterilization.**



19 x 7 x 2 cm
Single tier

No. 20840-01
\$ 52.50

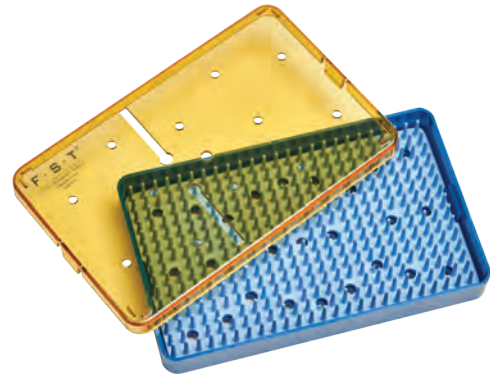

17 x 10 x 2 cm
Single tier

No. 20840-02
\$ 75.00

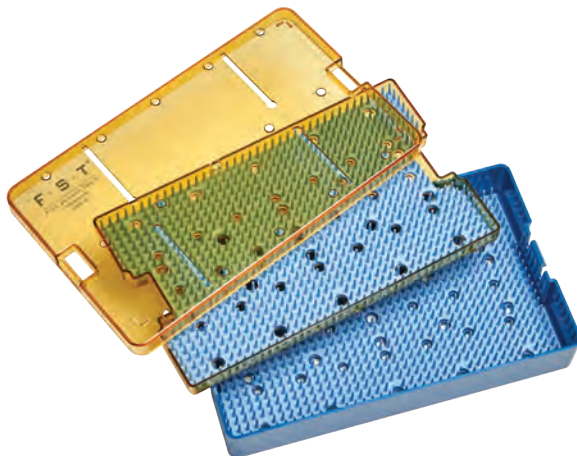

25 x 15 x 4 cm
Double tier

No. 20842-03
\$ 189.00

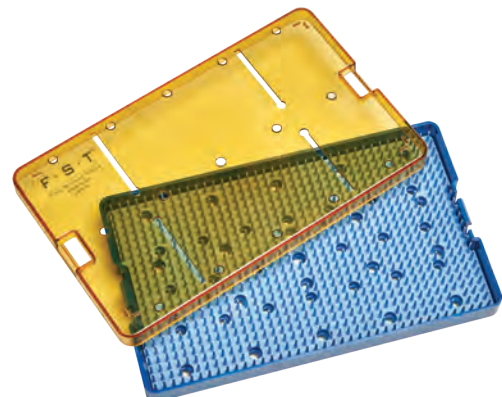

25 x 15 x 2 cm
Single tier

No. 20840-03
\$ 104.00

Colored Aluminum Cases

This instrument case comes with a spiked silicone mat for secure storage of surgical instruments. Five colors available but may vary due to lot to lot variations.

The case and silicone insert are autoclavable but should not be used for sterilization of surgical instruments.



Blue
18 x 9 x 3 cm

No. 20330-00
\$ 125.00



Red
18 x 9 x 3 cm

No. 20330-02
\$ 125.00



Green
18 x 9 x 3 cm

No. 20330-01
\$ 125.00



Yellow
18 x 9 x 3 cm

No. 20330-03
\$ 125.00



Silver
18 x 9 x 3 cm

No. 20330-04
\$ 125.00



INSTRUMENT CARE
& ACCESSORIES

Utility Instrument Case

Comes with a silicone mat for safe placement of instruments. **Case and silicone insert are autoclavable but should not be used for sterilizing surgical instruments.**

Moria



Silver
18 x 9 x 3 cm

No. 20311-21
\$ 144.50

Instrument Case

This plastic case is compact, safe, secure, and slotted for placement of individual surgical instruments, aiding in the prevention of tip damage. Seven colors available. **Case is autoclavable but should not be used for sterilizing surgical instruments.**



Instruments not included.

Blue



17 x 8 x 2 cm

No. 20830-00
\$ 10.50

Green



17 x 8 x 2 cm

No. 20830-01
\$ 10.50

Clear

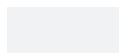

17 x 8 x 2 cm

No. 20830-02
\$ 10.50

Yellow



17 x 8 x 2 cm

No. 20830-03
\$ 10.50

Pink



17 x 8 x 2 cm

No. 20830-04
\$ 10.50

Orange



17 x 8 x 2 cm

No. 20830-05
\$ 10.50

Purple



17 x 8 x 2 cm

No. 20830-06
\$ 10.50

INSTRUMENT STORAGE

Roll Up Travel Case

Vinyl dissection roll up case with Velcro strap to hold the case closed. Holds up to ten tools, one ruler holder, and one Velcro sealed pouch. **Instruments not included.**

36 x 23 cm (unfolded)
Black
Vinyl

No. 20831-10

\$ 14.50



Instrument Tip Protectors

These tip protectors are a convenient, color-coded way to protect surgical instrument tips and edges. They provide exceptional protection and are vented to prevent rusting from condensation. Instrument tip protectors are recommended during handling, storage and sterilization. **Autoclavable.**



1.6 x 19.1 mm
Pkg. of 25
Material: Plastisol

No. 29060-01

\$ 11.50



2 x 19 mm
Pkg. of 25
Material: Plastisol

No. 29060-02

\$ 11.50



2.8 x 19.1 mm
Pkg. of 25
Material: Plastisol

No. 29060-03

\$ 11.50



3.2 x 25.4 mm
Pkg. of 25
Material: Plastisol

No. 29060-04

\$ 11.50



4.8 x 25.4 mm
Pkg. of 25
Material: Plastisol

No. 29060-05

\$ 11.50



9.5 x 25.4 mm
Pkg. of 25
Material: Plastisol

No. 29060-06

\$ 11.50



Assorted pack, five of each size
Pkg. of 30
Material: Plastisol

No. 29060-00

\$ 14.00



Double Tip Protectors

These vented tip protectors are designed to hold hemostats and rongeurs firmly while allowing the jaws, box hinge and tips to stay open for through sterilization. **Autoclavable.**



12.7 x 2 mm
Pkg. of 10
Material: Plastisol

No. 29066-01

\$ 9.50



9 x 25.5 mm
Pkg. of 10
Material: Plastisol

No. 29066-02

\$ 9.50



15 x 25 mm
Pkg. of 10
Material: Plastisol

No. 29066-03

\$ 9.50



25 x 26 mm
Pkg. of 10
Material: Plastisol

No. 29066-04

\$ 9.50



Assorted pack,
three of each size
Pkg. of 12
Material: Plastisol

No. 29066-00

\$ 12.00

Stainless Steel Burrs

Length: 44 mm
 Shaft Ø: 2.3 mm
 Pkg. of 10 burrs

Tip Ø (mm)	Item	Price
0.7 *	No. 19008-07	\$ 21.00
0.9 **	No. 19008-09	\$ 21.00
1.4	No. 19008-14	\$ 20.50

* Use this size for screws No. 19010-10 (page 68).
 ** Use this size for screws No. 19010-00 (page 68).



Carbon Steel Burrs

Length: 44 mm
 Shaft Ø: 2.3 mm
 Pkg. of 10 burrs



Tip Ø (mm)	Item	Price
0.5	No. 19007-05	\$ 18.00
0.7 *	No. 19007-07	\$ 16.00
0.9 **	No. 19007-09	\$ 16.00
1.4	No. 19007-14	\$ 16.00
2.1	No. 19007-21	\$ 16.00
2.9	No. 19007-29	\$ 26.00

* Use this size for screws No. 19010-10 (page 68).
 ** Use this size for screws No. 19010-00 (page 68).



Tungsten Carbide Burrs

Length: 44 mm
 Shaft Ø: 2.3 mm
 Pkg. of 5 burrs



Tip Ø (mm)	Item	Price
0.5	No. 19009-05	\$ 26.50
0.7 *	No. 19009-07	\$ 26.50
0.9 **	No. 19009-09	\$ 26.50

* Use this size for screws No. 19010-10 (page 68).
 ** Use this size for screws No. 19010-00 (page 68).



Stainless Steel Trephines

Side opening for clearing of material.

Length: 44 mm
 Shaft Ø: 2.3 mm
 Sold individually

1.8 - 2.7 mm 5 mm

Tip Outer Ø (mm)	Item	Price
1.8	No. 18004-18	\$ 19.50
2.3	No. 18004-23	\$ 20.00
2.7	No. 18004-27	\$ 24.00
5	No. 18004-50	\$ 36.50



Stainless Steel Circular Saw

For cutting bone and other hard substances. Attaches to mandrel (No. 18000-18), on the right side.



Ø: 16 mm
 Thickness: 0.1 mm
 Pkg. of 10 saws

No. 18000-20
\$ 33.50

Stainless Steel Mandrel

Screw allows attachment of discs and circular saws for use with high speed drills.



Length: 45 mm
 Shaft Ø: 2.3 mm

No. 18000-18
\$ 5.50

High Temperature Cautery Kit

This high temperature cauterizer is a great alternative to disposable cautery units. Temperature at tips is approximately 1000 °C (1832 °F). Replacement cautery tips are available. **Not autoclavable.**



Plastic body
 Stainless steel tips: 0.2 mm Ø
 Operation temperature: 1000 °C (1832 °F)
 Total weight: 70 g
 Length: 16 cm (without tip)

Cautery Kit

No. 18010-00

\$ 82.00

Cautery kit includes:

- 1 Cautery handle
- 2 AA batteries
- 2 Standard tips
- 2 Fine tips
- 1 Storage case



Replacement tips
Single use
 Straight / Standard
 Sterile: Yes

Box of 10 tips

No. 18010-01

\$ 77.00



Replacement tips
Single use
 Straight / Fine
 Sterile: Yes

Box of 10 tips

No. 18010-02

\$ 81.00

Low Temperature Cautery Kit

This low temperature cautery kit is a great alternative to disposable cautery units. Temperature at the tips is approximately 649 °C (1200 °F). Replacement cautery tips are available. **Not autoclavable.**



Plastic body
 Stainless steel tips: 0.2 mm Ø
 Operation temperature: 649 °C (1200 °F)
 Total weight: 60 g
 Length: 12 cm (without tip)

Cautery Kit

No. 18019-00

\$ 78.00

Cautery kit includes:

- 1 Cautery handle
- 1 AA battery
- 2 Fine tips
- 2 Elongated fine tips
- 1 Storage case



Replacement tips
Single use
 Straight / Fine
 Sterile: Yes

Box of 10 tips

No. 18019-01

\$ 74.50



Replacement tips
Single use
 Elongated Straight / Fine
 Sterile: Yes

Box of 10 tips

No. 18019-02

\$ 81.00

Small Vessel Cauterizer

This small hand-held unit keeps bleeding to a minimum and therefore provides a surgical field clear of clamps and hemostats. The cauterizer should be activated momentarily so the delicate tips do not burn out. Temperature at tips is approximately 1000 °C (1832 °F). Replacement cautery tips are available. **Autoclavable.**



Heavy gauge stainless steel body
Platinum-iridium tips: 0.3 mm Ø
Total weight: 100 g
Length: 13.5 cm (without tip)

Cautery Kit

No. 18000-00

\$ 429.50

Cautery kit includes:

- 1 Cautery handle
- 2 AA Batteries
- 1 Straight fine tip
- 1 Angled fine tip
- 1 Storage case



Remove batteries before autoclaving.



Replacement tips
Reusable
Straight / Fine

No. 18000-01

\$ 84.00



Replacement tips
Reusable
Angled / Fine

No. 18000-02

\$ 84.00



Replacement tips
Reusable
Straight / Fine

No. 18000-03

\$ 84.00



Replacement tips
Reusable
Straight knob

No. 18000-04

\$ 84.00

Neuro Punches

N.I.H. style neuro punches for punch removal of frozen brain microregions.

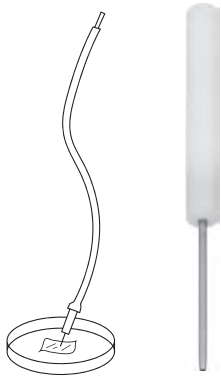

ID (mm)	OD (mm)	Gauge	Length (cm)	Item	Price
0.31	0.61	24	4.2	No. 18036-24	\$ 44.00
0.41	0.7	22	4.5	No. 18036-22	\$ 39.00
0.69	1	19	4.5	No. 18036-19	\$ 43.50

Sample Corers

For quantitative analysis. Comes with plunger.

8.5 cm

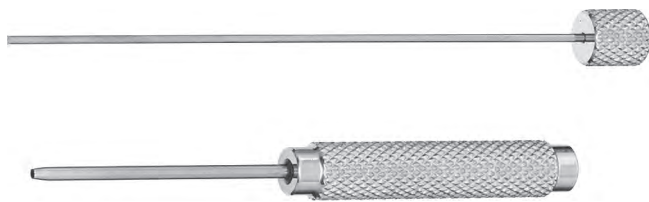

ID (mm)	OD (mm)	Gauge	Item	Price
0.35	0.8	21	No. 18035-35	\$ 89.50
0.5	1	19	No. 18035-50	\$ 74.00
0.8	1.45	17	No. 18035-80	\$ 74.00
1	1.8	15	No. 18035-01	\$ 68.50
2	3	11	No. 18035-02	\$ 68.50
3	4	8	No. 18035-03	\$ 68.50
5	6	4	No. 18035-05	\$ 78.50

Absorption Spears and Triangles

These synthetic surgical sponges absorb fluids twice as fast as the best cotton sponges and have three times their fluid-holding capacity. They are made from strong, soft, lint-free biocompatible-proven material that is nonirritating to delicate tissue and leaves no fibrous residue that might cause wound contamination. The Absorption Spears are sterilized by radiation.



Absorption Spears
7 cm
Sterile: Yes
Pkg. of 200 spears

No. 18105-01
\$ 169.00



Absorption Triangles
20 mm
Sterile: Yes
Pkg. of 200 triangles

No. 18105-04
\$ 76.00

Fiber Optic Swabs



Straight
15 cm
Tip Ø: 2.5 mm
Pack of 100

No. 18106-01
\$ 119.00

Micro Cleaning Brush



7 cm
Nylon
Bag of 25

No. 18196-10
\$ 7.00

Miniature File Set

Comes with eight different file profiles in a vinyl pouch.



10 cm
Carbon Steel

No. 30076-14
\$ 109.00

Instrument Sharpening Stones

Natural Arkansas oil stones feature unequalled fineness, hardness and structural density. When used with mineral oil, they will produce a sharper cutting edge.



6 mm x 9 cm
Square stone

No. 29008-01
\$ 15.50



6 mm x 9 cm
Triangular stone

No. 29008-12
\$ 15.50

4-in-1 Screwdriver

With four hardened, interchangeable blades stored in handle: 1.5, 2, 2.5, and 3 mm.



Handle 9.5 cm, with attachment 11.5 cm
Nickel handle

No. 30051-10
\$ 30.00

Ceramic Blade Cutter

Ceramic edge stays sharp 100 times longer than a steel edge. Rust and corrosion free. No trace metal contamination. **Autoclavable.**



Plastic handle with ceramic blade

Straight

13 cm

Cutting Edge: 58 mm

No. 10025-70
\$ 19.00

Replacement blade

Straight

Cutting Edge: 58 mm

No. 10025-71
\$ 13.00

UTILITY SCISSORS

Utility Scissors

These scissors are extremely hard (54 on the Rockwell scale). Useful for cutting tin or aluminum sheets, bone, plastics, etc. The strong, 3 mm thick blades are magnetic. The plastic handles are anatomically shaped.

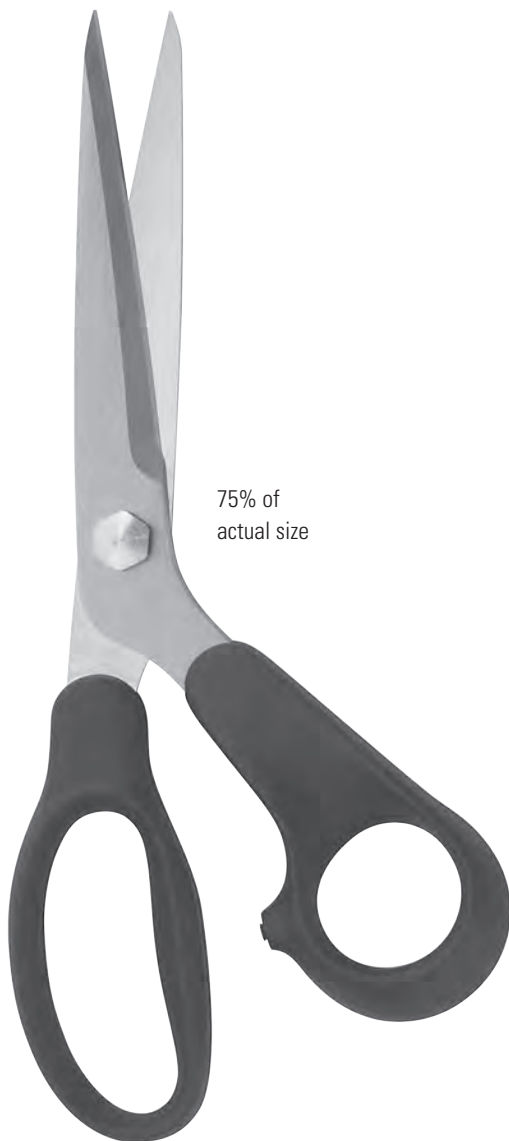

75% of
actual size

21 cm
Stainless steel with
plastic handle

No. 37500-00
\$ 28.00

Universal Scissors

The scissor blades are made of high quality stainless-steel and guarantee a perfect cut. Handles are made of glass fiber reinforced polyamide.



13 cm
Stainless steel with
plastic handle

No. 37500-05
\$ 24.50

Ruler with Gauge Measurements

Front

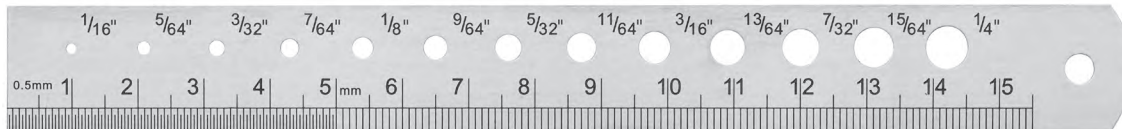

Back

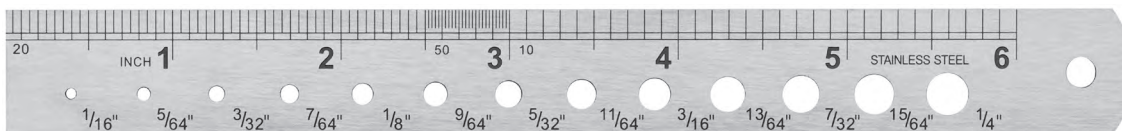

Stainless Steel
15.5 cm / 6"

No. 30085-15
\$ 6.50

Ruler with Metric Conversion Table

Front



Back



Stainless Steel
30 cm / 12"

50% of actual size

No. 30085-30
\$ 4.50

Ruler Label

Used for stable measurements in all surgical platforms.



6 cm
Pkg. of 25 labels

No. 29027-00
\$ 6.50

CALIPERS

Plastic Vernier Caliper

Tough polymer is unbreakable under normal conditions. Measures inside, outside, step and depth, metric and inch to 0.1 mm or 1/64".
Maximum measurement: 153 mm.



75% of
actual size

Plastic
21 cm

No. 30087-20
\$ 29.50

Digital Electronic Caliper

Wide screen LED display with the ability to measure in millimeters, inches and fractions. Measures inside, outside, step and depth. Battery, spare battery and plastic storage case included.



70% of
actual size

Stainless Steel
23.5 cm

No. 30087-00
\$ 33.50

Castroviejo Surgical Caliper

Used for precise measurement during surgery.



0-20 mm with 0.5 mm divisions
Tip Ø: 0.5 mm

8.5 cm

No. 18000-35
\$ 387.50

Magnifying Loupe with Micrometer and LED

High quality loupe features a removable micrometer and ultra-bright LED lights surrounding the circumference for a defined image and clear contrast.

Magnification: 10x
 Field of view: 30 mm
 Working distance: 10 mm (without scale)
 Ultrabright LED
 38 x 38 x 40 mm
No. 29026-10
\$ 131.00



76 x 26 mm
 1 mm with 100 divisions (0.01 mm)

No. 29025-02
\$ 174.50

Electronic Clock/Triple Timer

Three activities can be timed up or down simultaneously or individually. Time can be displayed either in 12 or 24 hours and features a memory function. Maximum countdown time is 19 hours, 59 minutes, 59 seconds. Minimum time interval is 1 second. The timer housing includes a powerful magnet for mounting.

LCD display: 4.5 x 4.5 cm
7 x 8.5 x 1.5 cm
AA battery (not included)

No. 27000-01

\$ 30.50

**Gold Wire Contacts**

Matching pin and socket. Contacts are crimp terminated, but also can be used for solder connections.

Enlarged 225%

Total length: 16 mm
Ø: 1.2 mm
Opening for wire: 0.63 mm

Pkg. of 50 Male contacts

No. 19003-00

\$ 92.50

Pkg. of 50 Female contacts

No. 19003-01

\$ 141.50

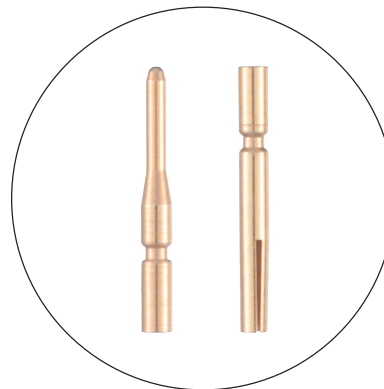

Headband Magnifier

Precision ground and polished optical glass lenses. The padded headband is lightweight and fully adjustable. Can be worn with spectacles.



Magnification: 2.5x
Working distance: 20 cm (8")

No. 28030-02

\$ 66.50

Magnification: 2.75x
Working distance: 15 cm (6")

No. 28030-03

\$ 75.00

Magnification: 3.5x
Working distance: 10 cm (4")

No. 28030-04

\$ 79.00

Interchangeable Magnifier Headset with LED

Economical and fully interchangeable headband magnifier with LED light.

Includes:

- Multiple Lens Magnifications (1.0x, 1.5x, 2.0x, 2.5x, 3.5x)
- LED Light Source
- Tilting Functionality
- Cushioned Nose Pads
- Adjustable Headband
- Interchangeable Lens Frames
- Requires 3 AAA Batteries (Batteries not included)



Can be used with or without the adjustable head strap (included).



Magnification: 1x, 1.5x, 2x, 2.5x and 3.5x
 Field of view: Variable
 Working distance: Variable

No. 28080-10
\$ 36.00

Galilean Loupes

These loupes are lightweight and easy to use. Made from the finest optical coated lenses which deliver excellent clarity and high resolution. The loupes are mounted onto a strong yet flexible wraparound safety frame with a headband for stability and comfort. Ability to flip loupes up for use as safety glasses. Comes with mini screwdriver for fine adjustments, micro cloth and storage case.



Magnification: 3x
Working distance: 40 cm (16")
Weight: 72 g

No. 28050-30
\$ 224.50

Magnification: 3.5x
Working distance: 30 cm (12")
Weight: 77 g

No. 28050-35
\$ 365.50

Eschenbach Magnifier Spectacles

These magnifier spectacles allow full adjustments on almost all parts. Headband keeps spectacles steady and in place. Leather case and Headband included.



Magnification: 2.5x
Working distance: 35 cm (14")
Weight: 70 g
Plastic frame reinforced with fiberglass

No. 28040-30
\$ 538.00

Spectacles Headband

Compatible with the Eschenbach Max Detail Spectacles (Item No. 28030-20) and Eschenbach Magnifier Spectacles (Item No. 28040-30).



Material: Neoprene

No. 28080-90
\$ 3.00

Eschenbach Max Detail Spectacles

These spectacles are portable, lightweight, and easily adjustable. Designed with frosted objective lens housing which eliminates distracting reflections. Bendable ear pieces for a secure, comfortable fit. Protective case is included.



Magnification: 2x
 Field of view: 110 mm (4")
 Working distance: 40 cm (16")
 Weight: 49 g

Max Detail Spectacles shown with Eschenbach Clip-On LED Light (sold separately).

No. 28030-20

\$ 152.00

Eschenbach Clip-On LED Light

A compact and lightweight light source with two high-performance SMD LEDs and a lens that concentrates the light producing a more powerful, bright and homogenous field of view. Light can be set high or low. Compatible with the Max Detail Spectacles and Head-band Magnifiers. Comes with 3 AA batteries, belt clip and storage case.



Weight: 106 g

No. 28030-25

\$ 155.00

Eschenbach Vario Flex with LED

The Vario LED Flex ensures ease and precision by its smooth flexible neck and tiltable magnifying lens. This magnifier's innovative features provide a spacious working platform suitable for any application. Mounting clamp provides uncompromised workspace due to its sturdy, slim design. The magnification lens is illuminated with shadow-free full or half ring optimum bright LEDs.

Magnification: 2.5x
 Diopter: 6D
 Lens size: 76 mm
 Lens shape: Aspheric
 Working distance: Variable
 Lens material: PXM® lightweight lens with patented Ceratec® scratch resistant coating
 Illumination: SMD LED
 Power source: 120 V & 230 V

No. 28015-25

\$ 667.00



Eschenbach Scribolux Magnifier

This magnifier provides an illuminated platform suitable for any working condition. The open design allows for a spacious working platform. Supplied in a microfiber pouch for protecting and cleaning the lens.

Magnification: 2.8x
 Diopter: 7/11D
 Lens size: 100 x 75 mm
 Lens shape: Aspheric
 Working distance: 7.5 cm (3")
 Lens material: PXM® lightweight lens with patented Ceratec® scratch resistant coating
 Illumination: SMD LED
 Power source: 6 V (4 AA-Batteries included)

No. 28020-28

\$ 184.00

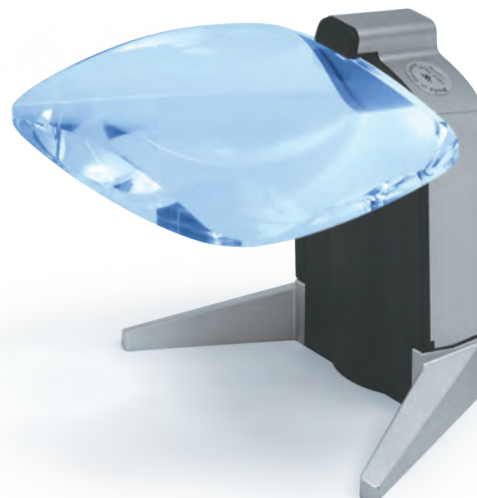

Eschenbach mobilux® DIGITAL inspection

The reflection-free and high-contrast 4.3-inch display ensures relaxed work. The HD camera arranged centrally under the display enables easy orientation. A magnification of up to 15x can be selected continuously or in increments by touching the magnifying glass symbol. The integrated LED lighting offers great variability in lighting and exposure settings for a wide variety of applications. The mobilux® offers measurement and comparison functions via adjustable scales and templates as well as simultaneous comparison measurements of the target and actual status via a split screen on the PC.

With the photo function, the live image seen through the magnifying glass can be saved as a photo on an inserted SD card. The images can also be easily transferred to a computer via a USB connection. In addition, the USB connection to the computer enables the live image of the magnifying glass to be transferred to the PC monitor, so the mobilux® can also be used as a screen reader. The "mobilux® digital" program supplied must first be installed on the computer (Windows Vista, Windows 7, 8 or Windows 10).

Delivery incl. USB cable length 2 m, SD memory card (incl. software), hand strap, manual, case for storage, calibration plate. Mains adapter for EU, GB, US, AUS included.

Magnification: 4 -15x
 Field of view: Variable
 Working distance: Variable
 Screen size: 11 cm (4.3")
 Screen resolution: 480 x 272 px
 User input: Touchscreen

No. 28070-50

\$ 525.00

**Eschenbach laboCOMFORT**

With the laboCOMFORT, both hands remain free to work. The screen can be folded up when not in use. Various locking options for individual height adjustment of the magnifying screen. The headband magnifier can also be used by people who wear glasses.



Can be used with the Eschenbach
 Clip-On LED light.

Magnification: 3x
 Working distance: 13 cm (5")

No. 28030-13

\$ 99.00

Optical Cleaning Kit

This convenient kit contains everything you need to clean lens surfaces safely. Perfect for microscopes, camera lenses, binoculars, telescopes, graphic art optics and all other fragile lenses. Storage case included.

Kit includes:

- 1 Bottle of lens cleaner (30 ml)
- 1 Ultra soft duster brush
- 1 Cleaning cloth (20 x 20 cm)
- 3 Books of lens paper (25 sheets each)



No. 29000-10

\$ 32.00

Lens Paper

This premium grade optical lens tissue is extremely soft and safe for any glass or plastic optical lens surface.



15 x 10 cm
Book of 50 sheets

No. 29015-50

\$ 4.00

STUDENT QUALITY INSTRUMENTS

Scissors 206 – 211

Cutters 211

Scalpel Handles 212

Forceps 213 – 218

Hemostats,
Pin & Needle Holders, Retractors,
Vessel Dilators & Clamps 219 – 227

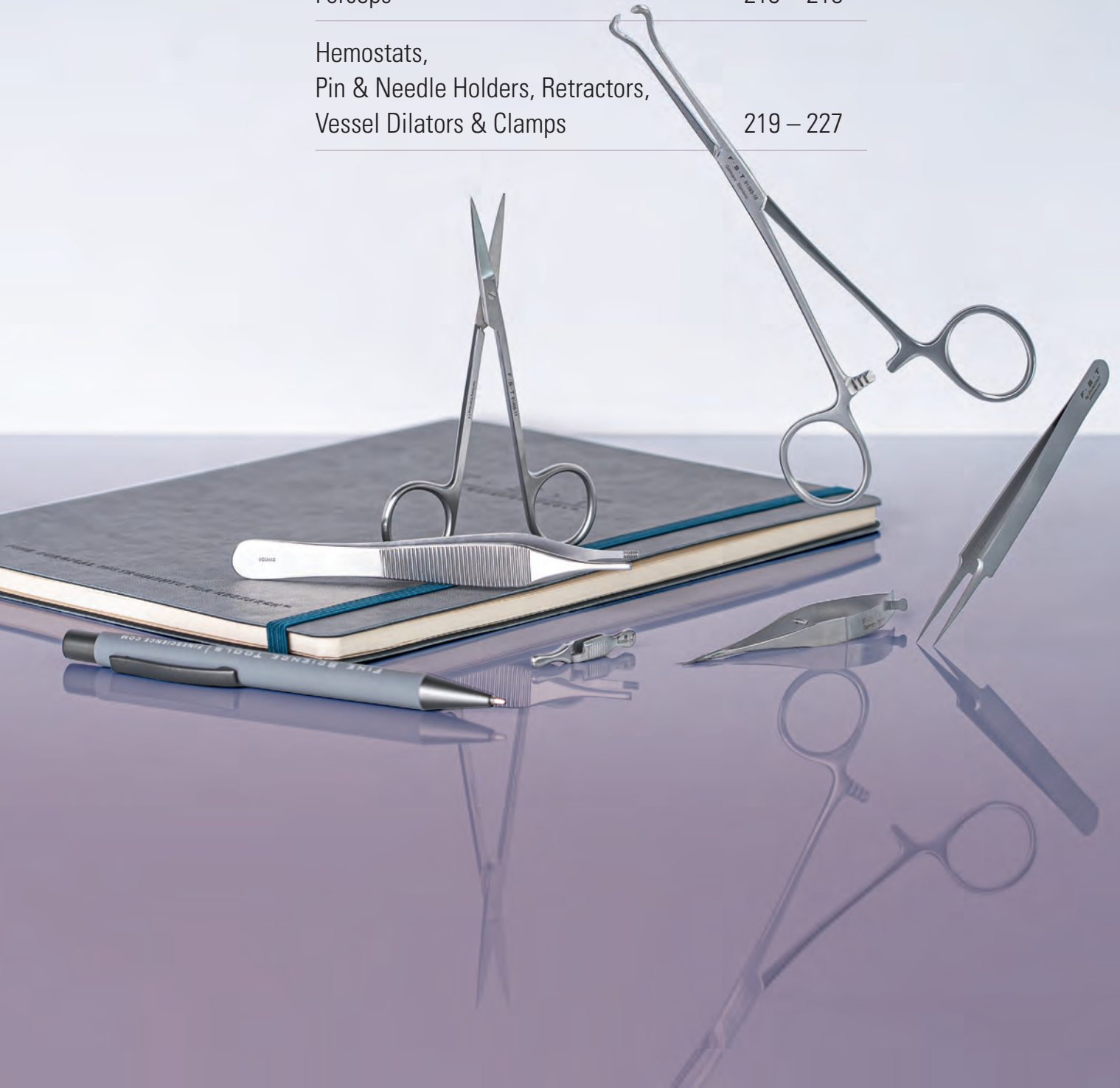

FST STUDENT LINE



FEATURES:

- Economy
- Quantity discounts
- Quality
- Less hand finishing
- Less expensive alloys

One of the hallmarks of FST has always been to accurately assess the needs of our customers. We gather information not only from the lab, but from conferences, journals and researchers. Whether it is designing new tools or finding new applications for existing instruments, we believe our best information comes directly from you.

Our customers wanted reduced costs and quantity discounts without sacrificing the precision and quality inherent in German instruments. To meet their needs, we have developed a full line of “student” instruments. They were created for use in the classroom where students are learning proper instrument care.

Unlike our competitors, the quality of these instruments does not drop dramatically with the price. Our student line uses quality stainless steel and maintains the precision you expect from FST. In addition they carry our unconditional satisfaction guarantee while being offered at a significantly reduced price.

Not intended as a substitute for our highest quality instruments, the student line may require extra care as the alloys used are more susceptible to corrosion. Visit our website at finescience.com for more information.

SCISSORS

Vannas Spring Scissors

Ideal for introductory courses in microdissection. The manufacturer, material and general pattern are the same as our No. 15003-08 but with much of the costly hand finishing omitted.



Fine Scissors



Sanvenero



Quantity discount for student instruments:
 5-9 = 5%
 10+ = 10%
 Per item, selection cannot be assorted for discount.



Straight Sharp/Sharp

9 cm
 Cutting edge: 5 mm
 Tip Ø: 0.35 mm

No. 91500-09
\$ 101.50



Curved Sharp/Sharp

9 cm
 Cutting edge: 5 mm
 Tip Ø: 0.35 mm

No. 91501-09
\$ 109.50



Straight Sharp/Sharp

11.5 cm
 Cutting edge: 16 mm

No. 91460-11
\$ 40.50



Curved Sharp/Sharp

11.5 cm
 Cutting edge: 16 mm

No. 91461-11
\$ 44.00



Straight Sharp/Sharp

14.5 cm
 Cutting edge: 22 mm

No. 91408-14
\$ 25.50

STUDENT INSTRUMENTS

Surgical Scissors



Length (cm)	Cutting edge (mm)	Straight Sharp / Sharp	Price	Straight Sharp / Blunt	Price	Straight Blunt / Blunt	Price
10.5	20	No. 91402-10	\$ 37.50	No. 91401-10	\$ 35.00	No. 91400-10	\$ 31.00
12	26	No. 91402-12	\$ 38.50	No. 91401-12	\$ 36.50	No. 91400-12	\$ 34.50
13	28	No. 91402-13	\$ 40.00	No. 91401-13	\$ 37.50		
14.5	30	No. 91402-14	\$ 41.50	No. 91401-14	\$ 38.50	No. 91400-14	\$ 33.50



Length (cm)	Cutting edge (mm)	Curved Sharp / Sharp	Price	Curved Sharp / Blunt	Price
12	26	No. 91405-11	\$ 38.00	No. 91404-12	\$ 36.50
13	28	No. 91405-13	\$ 40.00	No. 91404-13	\$ 37.50
14.5	30	No. 91405-14	\$ 41.50	No. 91404-14	\$ 38.50



DISCOUNT

Quantity discount for student instruments:
 5-9 = 5%
 10+ = 10%
 Per item, selection cannot be assorted for discount.

STUDENT INSTRUMENTS

Wagner



Spencer Ligature



% DISCOUNT

Quantity discount for student instruments:
 5-9 = **5%**
 10+ = **10%**
Per item, selection cannot be assorted for discount.



Straight Sharp/Sharp

11.5 cm
 Cutting edge: 20 mm

No. 91468-12
\$ 29.50



Straight Sharp/Sharp

9 cm
 Cutting edge: 16 mm

No. 91476-09
\$ 21.50

Lister Scissors

Longer blunt blade prevents damaging tissue underneath skin without losing the cutting line.



Mayo

80% of actual size



DISCOUNT

Quantity discount for student instruments:
 5-9 = 5%
 10+ = 10%
 Per item, selection cannot be assorted for discount.



**Angled to side
Blunt/Blunt**

14 cm
Cutting edge: 26 mm

No. 91413-14
\$ 27.00



**Angled to side
Blunt/Blunt**

18 cm
Cutting edge: 30 mm

No. 91413-18
\$ 27.50



**Angled to side
Blunt/Blunt**

20 cm
Cutting edge: 34 mm

No. 91413-20
\$ 28.00

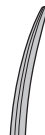

**Curved
Sharp/Blunt**

14.5 cm
Cutting edge: 28 mm

No. 91409-15
\$ 22.50



**Straight
Blunt/Blunt**

17 cm
Cutting edge: 32 mm

No. 91410-17
\$ 28.00

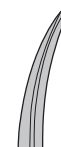

**Curved
Blunt/Blunt**

17 cm
Cutting edge: 32 mm

No. 91411-17
\$ 29.00

STUDENT INSTRUMENTS

Metzenbaum Baby

Metzenbaum



% DISCOUNT

Quantity discount for student instruments:
 5-9 = 5%
 10+ = 10%
 Per item, selection cannot be assorted for discount.



**Curved
Blunt/Blunt**

14.5 cm
Cutting edge: 22 mm

**No. 91419-14
\$ 30.50**



**Straight
Blunt/Blunt**

14.5 cm
Cutting edge: 22 mm

**No. 91416-14
\$ 30.00**

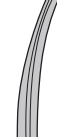

**Curved
Blunt/Blunt**

18 cm
Cutting edge: 24 mm

**No. 91417-18
\$ 30.50**

STUDENT INSTRUMENTS

Heavy Scissors



**Curved
Sharp/Sharp**

Heavy Blades
10.5 cm
Cutting edge: 20 mm

No. 91405-10
\$ 22.50

Bone Scissors

For cutting fine bone.



**Curved
Sharp/Sharp**

9 cm
Cutting edge: 14 mm

No. 91604-09
\$ 63.00

Bone Cutter

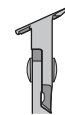

Angled 30°

11 cm
Cutting edge: 19.5 mm
Black plastic handle

No. 91601-11
\$ 113.00

DISCOUNT 

Quantity discount
for student
instruments:
5-9 = 5%
10+ = 10%
Per item, selection
cannot be assorted
for discount.

STUDENT INSTRUMENTS

SCALPEL HANDLES

Scalpel Handle #4



For scalpel blades,
see page 77.

13 cm

No. 91004-13
\$ 15.00

Standard Scalpel Handle #3



For scalpel blades,
see page 78.

12 cm

No. 91003-12
\$ 14.50

% DISCOUNT

**Quantity discount
for student
instruments:**
5-9 = 5%
10+ = 10%
*Per item, selection
cannot be assorted
for discount.*

STUDENT

Dumont #5

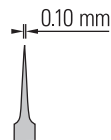

**Standard
Straight**

11 cm
Inox
0.1 x 0.06 mm

No. 91150-20
\$ 34.50

Dumont #7

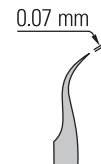

**Standard
Curved**

11 cm
Inox
0.17 x 0.1 mm

No. 91197-00
\$ 37.50

DISCOUNT

Quantity discount
for student
instruments:
5-9 = 5%
10+ = 10%
Per item, selection
cannot be assorted
for discount.

STUDENT

FINE FORCEPS

Fine Forceps Straight



Fine Forceps Broad Shanks



Fine Forceps Curved



Fine Forceps Angled



% DISCOUNT

Quantity discount for student instruments:
5-9 = 5%
10+ = 10%
Per item, selection cannot be assorted for discount.



Straight

11 cm
0.2 x 0.1 mm

No. 91115-10
\$ 30.00



Straight / Broad shanks

12 cm
0.2 x 0.2 mm

No. 91113-10
\$ 30.50



Curved

12 cm
0.2 x 0.2 mm

No. 91117-10
\$ 34.00



Angled

11 cm
0.2 x 0.2 mm

No. 91110-10
\$ 31.50

STUDENT INSTRUMENTS

Feilchenfeld



**Serrated/Sharp
 Straight**

9 cm
 Tip Ø: 0.75 mm

No. 91139-09
\$ 21.50

**Serrated/Sharp
 Straight**

11.5 cm
 Tip Ø: 1 mm

No. 91139-12
\$ 21.50

Splinter Forceps



**Serrated
 Straight**

10.5 cm
 Tip Ø: 0.3 mm

No. 91156-11
\$ 36.00

DISCOUNT 

Quantity discount
 for student
 instruments:
 5-9 = 5%
 10+ = 10%
 Per item, selection
 cannot be assorted
 for discount.

STUDENT INSTRUMENTS

Micro Adson



80% of actual size

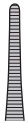

Serrated

12 cm

Tip width: 0.7 mm

No. 91118-12

\$ 25.50

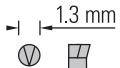

1x2 Teeth

12 cm

Tip width: 1.3 mm

No. 91119-12

\$ 25.50

Adson

Wide, strong grip with narrow tips.



80% of actual size



Serrated

12 cm

Tip width: 1.5 mm

No. 91106-12

\$ 25.00

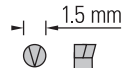

1x2 Teeth

12 cm

Tip width: 1.5 mm

No. 91127-12

\$ 35.00

Adson-Brown



Shark teeth

12 cm

Tip width: 2.5 mm

No. 91162-12

\$ 34.50

Adson with Cross Serrations



**1x2 Teeth/
Cross-serrations**

12 cm

Tip width: 1.3 mm

No. 91427-12

\$ 36.00

% DISCOUNT

Quantity discount for student instruments:

5-9 = 5%

10+ = 10%

Per item, selection cannot be assorted for discount.

STUDENT INSTRUMENTS

Anatomical and Surgical Forceps

Broad pattern with strong spring action.

Anatomical Standard Pattern



Tip width (mm)	Length (cm)	Item	Price
2.5	11.5	No. 91100-12	\$ 18.50
2.7	13	No. 91100-13	\$ 18.50
3	14.5	No. 91100-14	\$ 20.50
3.5	16	No. 91100-16	\$ 22.50
4	17	No. 91100-17	\$ 23.00

Surgical Standard Pattern



Tip width (mm)	Length (cm)	Item	Price
2.2	12	No. 91121-12	\$ 18.00
2.4	13	No. 91121-13	\$ 18.00
2.6	14.5	No. 91121-14	\$ 18.00
2.8	15.5	No. 91121-15	\$ 18.50
3	16	No. 91121-16	\$ 18.50
3.5	18	No. 91121-18	\$ 19.50
4	20	No. 91121-20	\$ 19.50
4.5	25	No. 91121-25	\$ 20.00



Anatomical Narrow Pattern

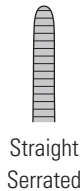

Tip width (mm)	Length (cm)	Item	Price
1.5	11.5	No. 91102-12	\$ 17.50
2.1	13	No. 91102-13	\$ 17.50
2.2	14.5	No. 91102-14	\$ 18.00
2.3	16	No. 91102-16	\$ 18.50

Surgical Narrow Pattern

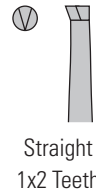

Tip width (mm)	Length (cm)	Item	Price
2	11.5	No. 91123-12	\$ 18.00
2.2	14.5	No. 91123-14	\$ 18.00
2.4	16	No. 91123-16	\$ 19.00



Quantity discount for student instruments:
 5-9 = 5%
 10+ = 10%
 Per item, selection cannot be assorted for discount.

STUDENT INSTRUMENTS

STANDARD FORCEPS

Semken



**Serrated
Straight**

11.5 cm
Tip width: 1.2 mm

No. 91108-12
\$ 25.00

Straight

14.5 cm
Tip width: 2.2 mm

No. 91108-14
\$ 24.50

Gillies



80% of
actual size

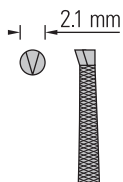

**1x2 Teeth and
Cross-Serrations**

15.5 cm
Tip width: 2.1 mm

No. 91128-15
\$ 34.50

Russian



80% of
actual size

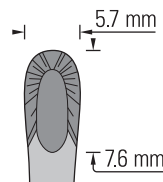

Serrated

15 cm
Tip dimension: 7.6 x 5.7 mm

No. 91126-15
\$ 19.50

McIndoe



80% of
actual size



Serrated

15 cm
Tip width: 1.2 mm

No. 91138-15
\$ 34.50

% DISCOUNT

**Quantity discount
for student
instruments:**
5-9 = **5%**
10+ = **10%**
*Per item, selection
cannot be assorted
for discount.*

STUDENT INSTRUMENTS

Halsted-Mosquito



Hartmann

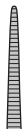

**Straight
Serrated**

12.5 cm
Tip width: 1.4 mm

No. 91308-12
\$ 39.00



**Curved
Serrated**

12.5 cm
Tip width: 1.4 mm

No. 91309-12
\$ 44.00

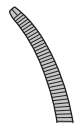

**Curved
1x2 Teeth and
Serrations**

12.5 cm
Tip width: 2 mm

No. 91331-12
\$ 33.00



**Curved
Serrated**

10 cm
Tip width: 1.5 mm

No. 91303-10
\$ 33.00

DISCOUNT

Quantity discount
for student
instruments:
5-9 = 5%
10+ = 10%
Per item, selection
cannot be assorted
for discount.

STUDENT INSTRUMENTS

Crile



80% of actual size



Straight Serrated

14 cm
Tip width: 1.5 mm

No. 91304-14
\$ 28.00

Straight Serrated

16 cm
Tip width: 2 mm

No. 91304-16
\$ 29.50

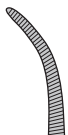

Curved Serrated

14 cm
Tip width: 1.5 mm

No. 91305-14
\$ 26.50

Curved Serrated

16 cm
Tip width: 2 mm

No. 91305-16
\$ 27.00

Kelly



Straight Serrated

14 cm
Tip width: 2 mm

No. 91318-14
\$ 30.00

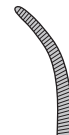

Curved Serrated

14 cm
Tip width: 2 mm

No. 91319-14
\$ 30.50

% DISCOUNT

Quantity discount for student instruments:
5-9 = 5%
10+ = 10%
Per item, selection cannot be assorted for discount.

STUDENT INSTRUMENTS

Rochester-Pean

Pean



80% of actual size



Straight Serrated

14 cm
Tip width: 2 mm

No. 91316-14
\$ 30.00

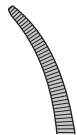

Curved Serrated

14 cm
Tip width: 2 mm

No. 91317-14
\$ 30.50

Straight Serrated

16 cm
Tip width: 2.5 mm

No. 91316-16
\$ 30.50

Curved Serrated

16 cm
Tip width: 2.5 mm

No. 91317-16
\$ 31.00



Straight Serrated Narrow

14 cm
Tip width: 2 mm

No. 91322-14
\$ 30.00

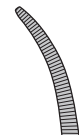

Curved Serrated Narrow

14 cm
Tip width: 2 mm

No. 91323-14
\$ 30.50

DISCOUNT

Quantity discount for student instruments:
5-9 = 5%
10+ = 10%
Per item, selection cannot be assorted for discount.

STUDENT INSTRUMENTS

HEMOSTATS

Ochsner-Kocher

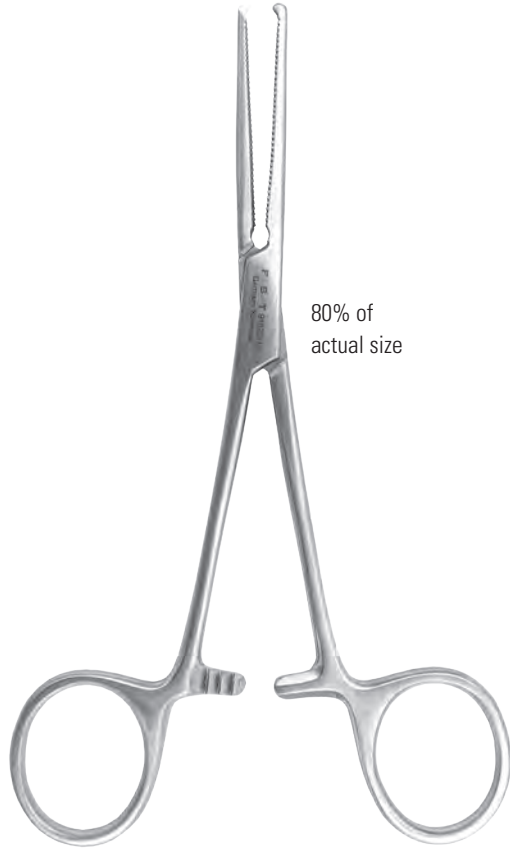

80% of actual size

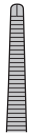

Straight
1x2 Teeth and Serrations

14 cm
Tip width: 2.2 mm

No. 91328-14
\$ 34.00

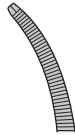

Curved
1x2 Teeth and Serrations

14 cm
Tip width: 2.2 mm

No. 91329-14
\$ 35.00

Straight
1x2 Teeth and Serrations

16 cm
Tip width: 3 mm

No. 91328-16
\$ 36.00

Curved
1x2 Teeth and Serrations

16 cm
Tip width: 3 mm

No. 91329-16
\$ 37.00

Kocher



Straight
1x2 Teeth and Serrations
Narrow

14 cm
Tip width: 2.2 mm

No. 91330-14
\$ 30.50

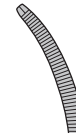

Curved
1x2 Teeth and Serrations
Narrow

14 cm
Tip width: 2.2 mm

No. 91331-14
\$ 31.00

% DISCOUNT

Quantity discount for student instruments:
5-9 = 5%
10+ = 10%
Per item, selection cannot be assorted for discount.

STUDENT INSTRUMENTS

Backhaus Towel Clamp



Tohoku Towel Clamp



Round and sharp tips

9 cm

No. 91195-09
\$ 20.00



Round and sharp tips

11 cm

No. 91195-11
\$ 20.50



Round and sharp tips

13 cm

No. 91195-13
\$ 21.00



Round and serrated tips

10 cm
Tip width: 2.5 mm

No. 91194-10
\$ 24.00



Round and serrated tips

13 cm
Tip width: 3 mm

No. 91194-13
\$ 24.50

DISCOUNT

Quantity discount for student instruments:
5-9 = 5%
10+ = 10%
Per item, selection cannot be assorted for discount.

STUDENT INSTRUMENTS

CLAMPS

Lorna Towel Clamp

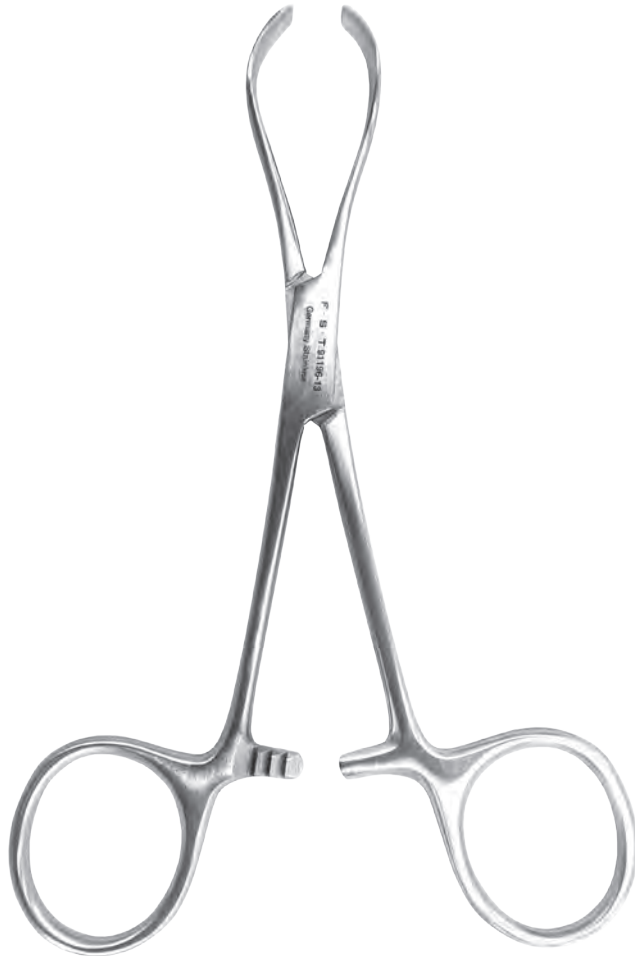

Serrated

13 cm
Tip width: 7 mm

No. 91196-13
\$ 22.50

Babcock



Serrated

16 cm
Tip width: 6 mm

No. 91393-16
\$ 30.50

% DISCOUNT

Quantity discount for student instruments:
5-9 = **5%**
10+ = **10%**
Per item, selection cannot be assorted for discount.

STUDENT INSTRUMENTS

Allis Clamp



60% of actual size

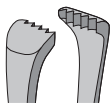

5x6 Teeth

15 cm
Tip width: 6 mm

No. 91191-15
\$ 26.00

Hose Clamp



60% of actual size

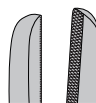

Cross-Serrated

15 cm
Tip width: 4 mm

No. 91198-15
\$ 24.00

Lister Sine Clamp

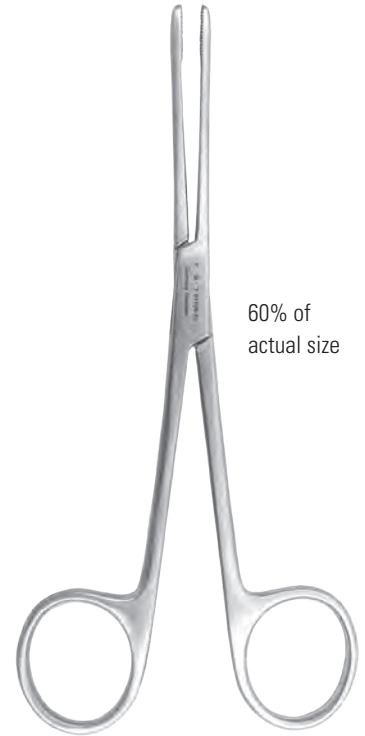

60% of actual size

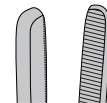

Serrated

16 cm
Tip width: 3 mm

No. 91199-16
\$ 23.50

DISCOUNT

Quantity discount for student instruments:
5-9 = 5%
10+ = 10%
Per item, selection cannot be assorted for discount.

STUDENT INSTRUMENTS

Pin Holder



% DISCOUNT

Quantity discount for student instruments:
5-9 = 5%
10+ = 10%
Per item, selection cannot be assorted for discount.

For pins, see page 147.

Nickel-plated

7.5 cm
Jaw opening: 0 to 1 mm

No. 91606-07
\$ 15.50

Halsey



80% of actual size

For suture needles, see page 154, 155.



Straight

13 cm
Tip width: 1.5 mm
Clamping length: 18 mm
Lockable: Yes
Scissors: No

No. 91201-13
\$ 52.50

Mayo-Hegar

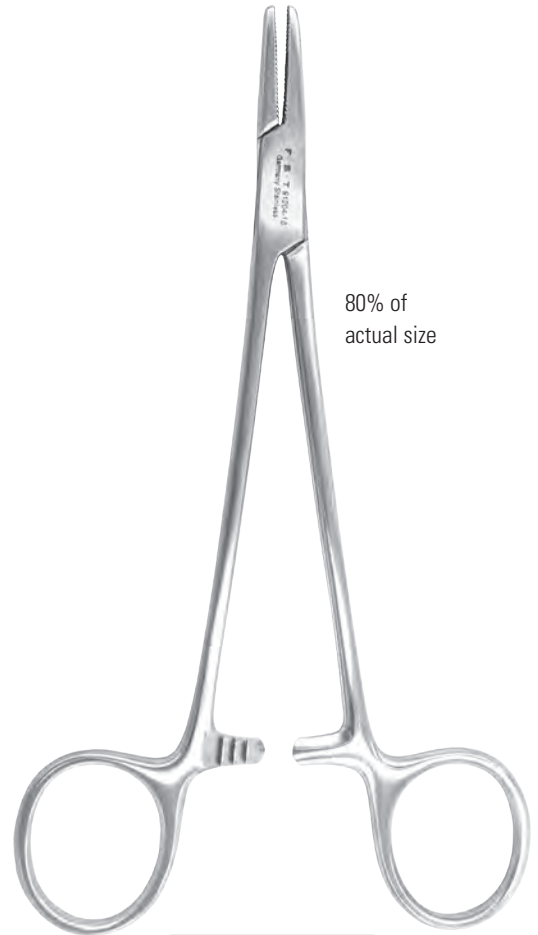

80% of actual size

For suture needles, see page 154, 155.



Straight

16 cm
Tip width: 2.6 mm
Clamping length: 21 mm
Lockable: Yes
Scissors: No

No. 91204-16
\$ 44.50

Senn-Miller

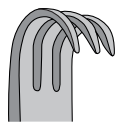

16 cm

3 sharp teeth 7 x 8 mm and
1 blunt tooth 18 x 6 mm

No. 91790-16

\$ 33.00

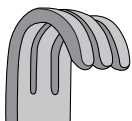

16 cm

3 blunt teeth 7 x 8 mm and
1 blunt tooth 18 x 6 mm

No. 91791-16

\$ 33.00

Vessel Dilator



Angled 10°

11 cm

Tip Ø: 0.3 mm

No. 91815-11

\$ 111.50

Spring-Loaded Retractor

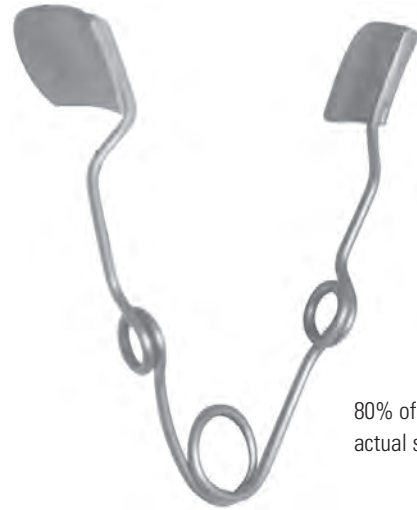

80% of
actual size

Atraumatic blades
8.5 cm
Maximum spread: 3 cm

No. 91706-05

\$ 44.00

Barraquer

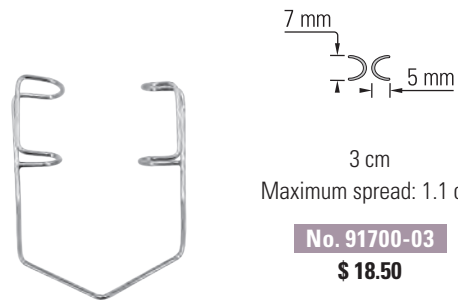

3 cm
Maximum spread: 1.1 cm

No. 91700-03

\$ 18.50

DISCOUNT 0%

Quantity discount
for student
instruments:
5-9 = 5%
10+ = 10%
Per item, selection
cannot be assorted
for discount.

Dieffenbach



Straight

35 mm

Strong pressure

No. 91850-35

\$ 32.50

NUMERICAL INDEX

00071-14	124	10035-00	76	10110-07	73	11003-13	110	11043-08	103	11200-33	91
00072-14	124	10035-05	76	10130-05	147	11003-14	110	11049-10	104	11203-23	91
00108-11	99	10035-10	76	10130-10	147	11003-16	110	11050-10	104	11203-25	91
00109-11	99	10035-12	76	10130-20	147	11003-18	110	11051-10	104	11210-10	91
00125-11	130	10035-15	76	10140-01	137	11003-20	110	11052-10	104	11210-20	91
00126-11	130	10035-20	76	10140-02	137	11006-12	108	11053-10	104	11215-01	61
00272-13	101	10035-25	76	10140-03	137	11006-15	102	11054-10	104	11215-02	61
00276-13	130	10035-30	76	10140-04	137	11008-13	111	11055-10	104	11220-21	90
00325-00	123	10050-00	75	10152-30	72	11008-15	111	11062-10	105	11223-20	90
00396-01	123	10052-11	75	10157-13	72	11009-13	111	11063-07	101	11229-08	92
00398-02	123	10053-09	75	10157-15	72	11009-15	111	11064-07	103	11229-10	92
00400-03	123	10053-13	75	10157-18	72	11010-17	116	11065-07	103	11231-20	88
00574-11	133	10055-12	70	10160-13	139	11011-17	116	11066-07	103	11231-30	88
00608-11	133	10056-12	70	10162-12	135	11012-18	116	11067-07	103	11241-30	90
00632-11	99	10058-15	71	10165-11	138	11012-21	116	11069-08	103	11242-40	90
00649-11	99	10059-13	70	10166-11	138	11012-25	116	11070-08	103	11251-10	85
10000-10	80	10059-15	71	10167-11	138	11013-18	116	11071-10	105	11251-20	85
10000-11	80	10060-00	80	10290-13	139	11013-21	116	11072-11	107	11251-21	86
10000-15	80	10060-13	80	10315-12	76	11014-18	115	11073-10	106	11251-23	85
10002-00	79	10061-12	137	10316-14	76	11015-18	115	11074-02	106	11251-30	85
10002-50	79	10062-12	137	10317-14	76	11016-17	116	11075-00	106	11251-33	87
10003-12	78	10063-15	136	10318-14	76	11017-17	116	11076-15	111	11251-35	87
10003-13	78	10064-14	137	10321-08	145	11018-12	108	11080-02	115	11252-00	83
10004-13	77	10065-15	136	10360-13	145	11019-12	108	11083-07	100	11252-20	85
10006-12	81	10066-15	136	10370-13	71	11020-12	108	11084-07	100	11252-21	86
10007-12	79	10073-14	70	10370-17	145	11021-12	113	11090-09	100	11252-23	85
10007-16	79	10075-16	69	10370-18	145	11021-14	113	11090-10	100	11252-30	85
10009-13	77	10080-05	69	10370-19	145	11021-15	113	11091-15	122	11252-40	85
10010-00	78	10081-10	69	11000-12	110	11022-12	108	11092-12	122	11252-50	83
10010-10	81	10082-15	69	11000-13	110	11022-14	113	11093-10	100	11253-10	86
10011-00	78	10083-20	69	11000-14	110	11022-15	113	11095-09	121	11253-20	84
10011-10	81	10087-12	141	11000-16	110	11023-10	113	11095-13	121	11253-21	84
10012-00	78	10088-15	139	11000-18	110	11023-12	113	11096-10	122	11253-25	84
10015-00	78	10089-11	141	11000-20	110	11023-14	113	11096-13	122	11253-27	87
10015-10	81	10090-13	140	11000-25	110	11023-15	113	11101-09	107	11253-29	84
10020-00	77	10090-17	140	11000-30	110	11024-12	111	11103-09	107	11254-20	83
10021-00	77	10091-12	141	11001-12	110	11024-18	116	11106-09	107	11255-20	85
10022-00	77	10092-12	142	11001-13	110	11025-18	116	11150-10	104	11258-20	92
10023-00	77	10093-13	142	11001-14	110	11026-15	114	11151-10	104	11260-20	88
10025-23	74	10094-13	142	11001-16	110	11027-12	108	11152-10	104	11270-20	89
10025-43	74	10095-12	69	11001-18	110	11028-15	114	11153-10	104	11271-30	89
10025-44	74	10096-16	69	11001-20	110	11029-14	113	11154-10	104	11272-30	89
10025-45	74	10098-06	143	11002-12	110	11030-12	109	11155-10	104	11272-40	85
10025-50	74	10099-12	144	11002-13	110	11031-15	114	11158-10	104	11272-50	89
10025-70	191	10099-15	144	11002-14	110	11032-12	108	11159-10	104	11273-20	84
10025-71	191	10100-30	74	11002-16	110	11036-20	116	11160-10	104	11273-22	84
10030-13	136	10100-45	74	11002-18	110	11036-90	116	11200-00	175	11274-20	89
10031-13	136	10110-01	73	11002-20	110	11040-08	103	11200-10	92	11280-11	133
10032-13	136	10110-03	73	11002-25	110	11041-08	103	11200-12	92	11281-11	133
10033-13	136	10110-05	73	11003-12	110	11042-08	103	11200-14	92	11282-11	133

11293-00	88	11972-20	96	12076-12	149	14003-13	48	14061-09	36	14116-18	52
11294-00	90	11980-13	95	12080-14	149	14003-14	48	14061-10	36	14117-14	52
11295-00	85	11988-01	95	12081-14	149	14003-16	48	14061-11	36	14117-18	52
11295-10	85	11988-02	95	12102-12	152	14003-18	48	14062-09	36	14130-17	49
11295-20	83	11988-03	95	12500-12	151	14003-20	48	14062-10	36	14131-14	50
11295-51	85	11990-14	94	12501-13	151	14004-12	48	14063-09	36	14160-10	37
11297-00	89	11991-14	94	12502-12	152	14004-13	48	14063-11	36	14161-10	37
11297-10	89	11992-12	94	12502-14	152	14004-14	48	14064-11	43	14171-10	47
11370-31	97	11992-20	96	12503-15	153	14004-16	48	14065-11	43	14173-12	44
11370-32	97	12001-13	151	12504-15	153	14004-18	48	14066-11	43	14184-09	35
11370-40	97	12002-12	152	12510-14	150	14005-12	48	14067-11	43	14185-09	35
11370-42	97	12002-14	152	12512-12	152	14005-13	48	14068-12	38	14200-21	54
11373-12	97	12003-15	153	12565-14	150	14005-14	48	14069-12	38	14370-22	37
11373-22	97	12004-16	152	12875-13	148	14005-16	48	14070-12	38	14501-14	49
11383-50	98	12004-18	152	13002-10	121	14007-14	50	14071-12	38	14502-14	49
11383-56	98	12005-15	153	13003-10	121	14008-14	48	14072-10	46	14504-14	49
11390-25	98	12010-14	150	13004-14	119	14010-15	53	14074-09	42	14505-14	49
11393-04	101	12018-12	157	13005-14	119	14010-17	53	14074-11	42	14508-15	51
11393-05	101	12020-00	159	13006-12	117	14011-15	53	14075-09	42	14509-15	51
11399-80	97	12020-09	159	13007-12	117	14011-17	53	14075-11	42	14510-15	53
11399-87	97	12022-09	159	13008-12	118	14012-15	54	14076-09	45	14510-17	53
11412-11	95	12022-19	159	13009-12	118	14012-17	54	14077-09	43	14511-15	53
11413-11	95	12023-00	159	13010-12	118	14013-15	54	14077-10	43	14511-17	53
11445-12	95	12028-12	157	13011-12	118	14013-17	54	14078-10	39	14512-15	53
11480-11	96	12029-12	157	13012-12	118	14014-17	54	14079-10	39	14512-17	53
11485-11	96	12030-01	158	13013-14	120	14015-17	54	14080-11	46	14518-14	51
11487-11	96	12030-04	158	13014-14	120	14016-14	52	14081-09	45	14518-18	51
11506-12	108	12030-20	158	13015-14	120	14016-18	52	14082-09	45	14519-14	51
11515-02	61	12030-22	158	13018-14	119	14017-14	52	14083-08	34	14519-18	51
11602-14	110	12030-23	158	13019-14	119	14017-18	52	14084-08	34	14558-09	41
11602-16	115	12035-00	158	13020-12	117	14018-13	51	14084-09	35	14558-11	41
11608-15	111	12040-01	157	13021-12	117	14018-14	51	14085-08	34	14559-09	41
11616-15	109	12040-02	157	13108-12	118	14018-18	51	14085-09	35	14559-11	41
11617-12	109	12040-03	157	13109-12	118	14019-13	51	14086-09	46	14568-09	40
11626-11	87	12050-01	155	14000-12	48	14019-14	51	14088-10	37	14568-12	40
11627-12	109	12050-02	155	14000-13	48	14019-18	51	14090-09	35	14569-09	40
11650-10	104	12050-03	155	14000-14	48	14024-14	52	14090-11	35	14569-12	40
11651-10	104	12050-10	155	14000-16	48	14028-10	39	14091-09	35	14574-09	42
11652-10	104	12050-20	155	14000-18	48	14029-10	39	14091-11	35	14574-11	42
11700-00	106	12052-08	154	14000-20	48	14037-10	47	14094-11	36	14575-09	42
11700-01	106	12052-09	154	14001-12	48	14040-10	38	14095-11	36	14575-11	42
11700-02	106	12052-10	154	14001-13	48	14041-10	38	14101-14	50	14854-10	34
11700-03	106	12052-11	154	14001-14	48	14054-13	49	14105-12	44	14855-10	34
11700-04	106	12060-01	148	14001-16	48	14058-09	40	14106-09	47	14958-09	41
11851-20	93	12060-02	148	14001-18	48	14058-11	40	14108-09	47	14958-11	41
11852-20	93	12061-01	148	14002-12	48	14059-09	40	14110-15	53	14959-09	41
11911-11	93	12061-02	148	14002-13	48	14059-11	40	14110-17	53	14959-11	41
11915-11	93	12074-12	149	14002-14	48	14060-09	36	14111-15	53	15000-00	21
11917-12	93	12075-12	149	14002-16	48	14060-10	36	14111-17	53	15000-01	24
11923-13	94	12075-14	149	14003-12	48	14060-11	36	14116-14	52	15000-02	24

NUMERICAL INDEX

15000-03	21	15396-00	24	16152-15	64	18004-27	187	18052-03	127	18105-04	190
15000-04	21	15396-01	24	16220-14	55	18004-50	187	18052-12	131	18106-01	190
15000-08	21	15400-12	30	16221-14	55	18010-00	188	18053-28	127	18131-12	130
15000-10	21	15401-12	30	17000-01	161	18010-01	188	18054-28	127	18132-12	130
15000-11	24	15403-08	22	17000-02	161	18010-02	188	18055-01	126	18144-30	126
15000-12	24	15404-08	22	17000-03	161	18019-00	188	18055-02	126	18155-13	105
15001-08	21	15514-12	29	17000-04	161	18019-01	188	18055-03	126	18196-10	190
15002-08	21	15610-08	24	17002-02	161	18019-02	188	18055-04	126	18200-01	167
15003-08	22	15615-08	24	17003-03	161	18020-00	155	18055-05	126	18200-02	167
15004-08	22	15617-08	24	17004-03	161	18020-01	155	18055-06	126	18200-03	167
15005-08	22	15650-11	25	17004-05	162	18020-02	155	18056-14	125	18200-04	167
15006-09	26	15651-11	25	17005-03	161	18020-03	155	18057-14	125	18200-05	167
15007-08	23	15750-11	25	17005-04	162	18020-20	155	18058-15	126	18200-06	167
15008-08	22	15751-11	25	17006-05	164	18020-30	155	18058-18	126	18200-07	167
15009-08	23	15903-08	22	17007-08	164	18020-40	155	18059-14	125	18200-08	167
15010-09	27	15904-08	22	17008-07	163	18020-50	155	18060-18	169	18200-09	167
15010-10	27	16000-14	59	17009-07	163	18020-60	155	18060-20	169	18200-10	167
15011-12	29	16001-15	57	17009-08	163	18020-70	155	18060-22	169	18200-11	167
15012-12	29	16002-18	58	17010-07	163	18025-10	101	18060-24	169	18200-12	167
15013-12	29	16004-16	59	17011-10	165	18026-10	102	18061-10	169	18200-20	167
15015-11	28	16005-16	59	17012-11	166	18030-30	155	18061-15	170	18200-50	167
15017-10	26	16015-17	57	17012-13	166	18030-40	155	18061-18	170	18320-11	126
15018-10	28	16016-17	57	17017-10	165	18030-50	155	18061-20	170	18374-43	126
15019-10	28	16020-14	56	17018-11	166	18030-60	155	18061-22	169	18374-44	126
15020-15	30	16021-14	56	17020-17	160	18030-70	155	18061-24	169	18403-11	133
15021-15	30	16022-15	58	17021-13	160	18030-80	155	18061-38	169	18406-11	133
15023-10	25	16023-15	58	17022-13	160	18035-01	190	18061-50	169	18406-13	133
15024-10	25	16025-14	67	17023-13	160	18035-02	190	18061-75	169	18555-01	126
15025-10	25	16030-12	64	17300-02	162	18035-03	190	18062-12	131	18555-02	126
15027-18	31	16030-16	64	17300-03	162	18035-05	190	18062-13	131	18555-03	126
15030-14	32	16044-10	64	17300-04	162	18035-35	190	18063-13	131	18555-04	126
15031-14	32	16050-15	65	17370-53	162	18035-50	190	18063-20	169	18601-15	112
15032-08	33	16060-11	68	18000-00	189	18035-80	190	18064-20	169	18602-15	112
15033-09	26	16101-10	62	18000-01	189	18036-19	190	18065-20	169	18603-14	112
15036-14	32	16102-11	62	18000-02	189	18036-22	190	18067-10	169	18961-15	170
15037-14	32	16104-14	66	18000-03	189	18036-24	190	18067-11	135	18961-17	170
15040-11	27	16104-19	66	18000-04	189	18038-45	127	18067-20	169	18961-18	170
15042-11	27	16105-16	66	18000-10	132	18039-45	127	18067-50	169	18961-20	170
15043-08	23	16106-14	66	18000-18	187	18040-11	123	18067-75	169	18961-75	170
15044-08	23	16107-14	60	18000-20	187	18040-14	124	18070-00	128	18961-85	170
15070-08	23	16109-14	60	18000-30	173	18040-22	123	18070-10	128	19003-00	196
15071-08	23	16120-14	56	18000-35	194	18040-33	123	18073-00	128	19003-01	196
15110-08	31	16121-14	56	18000-45	178	18050-28	127	18080-01	129	19007-05	187
15111-08	31	16130-15	65	18000-46	178	18050-35	127	18080-02	129	19007-07	187
15123-12	30	16140-11	63	18000-47	179	18050-50	127	18080-03	129	19007-09	187
15124-12	30	16143-12	63	18000-50	178	18051-28	127	18090-45	179	19007-14	187
15300-00	33	16144-13	63	18000-51	178	18051-35	127	18090-46	179	19007-21	187
15370-50	27	16150-24	67	18000-52	179	18051-50	127	18090-50	179	19007-29	187
15370-52	27	16152-11	64	18004-18	187	18052-01	127	18090-51	179	19008-07	187
15371-92	28	16152-12	64	18004-23	187	18052-02	127	18105-01	190	19008-09	187

19008-14	187	24213-02	172	28020-20	180	29071-06	176	91156-11	215	91404-14	207
19009-00	68	24213-12	172	28020-28	201	29071-08	176	91162-12	216	91405-10	211
19009-05	187	24214-02	172	28030-02	197	29071-09	176	91191-15	225	91405-11	207
19009-07	187	24215-02	171	28030-03	197	29080-02	176	91194-10	223	91405-13	207
19009-09	187	24220-00	174	28030-04	197	30051-10	191	91194-13	223	91405-14	207
19010-00	68	24221-10	174	28030-13	202	30076-14	191	91195-09	223	91408-14	206
19010-01	68	24221-50	174	28030-20	200	30085-15	193	91195-11	223	91409-15	209
19010-10	68	24221-90	174	28030-25	200	30085-30	193	91195-13	223	91410-17	209
19010-11	68	24916-01	171	28040-30	199	30087-00	194	91196-13	224	91411-17	209
20311-21	185	24916-02	171	28050-30	199	30087-20	194	91197-00	213	91413-14	209
20325-00	181	26000-25	147	28050-35	199	37500-00	192	91198-15	225	91413-18	209
20325-10	181	26000-30	147	28070-50	202	37500-05	192	91199-16	225	91413-20	209
20330-00	184	26000-35	147	28080-10	198	91003-12	212	91201-13	226	91416-14	210
20330-01	184	26000-40	147	28080-90	199	91004-13	212	91204-16	226	91417-18	210
20330-02	184	26000-45	147	29000-00	175	91100-12	217	91303-10	219	91419-14	210
20330-03	184	26000-50	147	29000-10	203	91100-13	217	91304-14	220	91427-12	216
20330-04	184	26000-55	147	29008-01	191	91100-14	217	91304-16	220	91460-11	206
20350-00	181	26000-60	147	29008-12	191	91100-16	217	91305-14	220	91461-11	206
20810-01	182	26000-65	147	29008-22	175	91100-17	217	91305-16	220	91468-12	208
20810-02	182	26000-70	147	29015-50	203	91102-12	217	91308-12	219	91476-09	208
20830-00	185	26001-25	147	29025-02	195	91102-13	217	91309-12	219	91500-09	206
20830-01	185	26001-30	147	29026-10	195	91102-14	217	91316-14	221	91501-09	206
20830-02	185	26001-35	147	29027-00	193	91102-16	217	91316-16	221	91601-11	211
20830-03	185	26001-40	147	29055-00	175	91106-12	216	91317-14	221	91604-09	211
20830-04	185	26001-45	147	29060-00	186	91108-12	218	91317-16	221	91606-07	226
20830-05	185	26001-50	147	29060-01	186	91108-14	218	91318-14	220	91700-03	227
20830-06	185	26001-55	147	29060-02	186	91110-10	214	91319-14	220	91706-05	227
20831-10	186	26001-60	147	29060-03	186	91113-10	214	91322-14	221	91790-16	227
20840-01	183	26001-65	147	29060-04	186	91115-10	214	91323-14	221	91791-16	227
20840-02	183	26001-70	147	29060-05	186	91117-10	214	91328-14	222	91815-11	227
20840-03	183	26002-10	147	29060-06	186	91118-12	216	91328-16	222	91850-35	227
20842-03	183	26002-15	147	29066-00	186	91119-12	216	91329-14	222		
20850-00	182	26002-20	147	29066-01	186	91121-12	217	91329-16	222		
20850-10	182	26003-15	147	29066-02	186	91121-13	217	91330-14	222		
20850-11	182	26007-01	147	29066-03	186	91121-14	217	91331-12	219		
23005-10	156	26007-02	147	29066-04	186	91121-15	217	91331-14	222		
24202-01	173	26007-03	147	29070-01	176	91121-16	217	91393-16	224		
24202-02	173	26007-04	147	29070-02	176	91121-18	217	91400-10	207		
24202-03	173	26007-05	147	29070-03	176	91121-20	217	91400-12	207		
24202-04	173	26016-12	146	29070-04	176	91121-25	217	91400-14	207		
24202-05	173	26018-17	146	29070-05	176	91123-12	217	91401-10	207		
24202-06	173	26029-10	107	29070-06	176	91123-14	217	91401-12	207		
24202-11	173	26030-10	107	29070-07	176	91123-16	217	91401-13	207		
24202-12	173	27000-01	196	29070-08	176	91126-15	218	91401-14	207		
24202-13	173	28000-07	177	29070-09	176	91127-12	216	91402-10	207		
24202-14	173	28000-10	177	29071-01	176	91128-15	218	91402-12	207		
24202-15	173	28000-12	177	29071-02	176	91138-15	218	91402-13	207		
24202-16	173	28001-02	180	29071-03	176	91139-09	215	91402-14	207		
24212-01	172	28015-15	180	29071-04	176	91139-12	215	91404-12	207		
24212-02	172	28015-25	201	29071-05	176	91150-20	213	91404-13	207		

ALPHABETICAL INDEX

A

Absorption swabs	190
Adson DeBakey Forceps	109
Adson Forceps	108,216
Adson-Brown Forceps	109,216
Adson-Graefe Forceps	109
Agricola Retractor	162
Allis Clamp Forceps	122,225
Alm Retractors	163
Animal Identification	
Ear Punch	171-172
Ear Tags	174
Markers	173
Autoclave Tape	180

B

Babcock Clamp	224
Baby-Beyer Rongeurs	58
Baby-Mixter Hemostat	120
Backhaus Towel Clamp	121,223
Barraquer Retractors	227
BeeBee Bone Scissors	64
Beyer Rongeur	58
Biemer	
Clip Applicator	125
Clips	126
Spring Scissors	33
Bishop-Harman	103
Blair Retractor	160
Boehler Bone Cutter	65
Bone	
Austin Chisel	69
Dissecting Chisel	69
Forceps	68
Nipper	62
Scissors	211
Scraper	69
Screws	68
Spring Scissors	63
Wax	68
Bonn	
Forceps	100
Micro Probe	136
Scissors	34-35,46
Bonn-Strabismus Scissors	35
Breakable Scalpels	75
Bulldog Clamps	126-127

C

Calipers	194
Cannulation System	132
Carbon Steel Blades	76
Castroviejo	
Needle Holder	148,150
Spring Scissors	25-26
Surgical Caliper	194
Cataract Knife	70
Cauterizer	188-189
Ceramic	
Scalpel Handle	74

Scalpels	74,191
Ceramic Coated	
Forceps	83,89
Iris Scissors	41
Spring Scissors	25
Circular Saw	187
Cleaning Brush	190
Cleveland Bone Cutter	66
Clipper II Spring Scissors	33
Clips (Vascular)	
Biemer	126
Bulldog Artery Spring Clamp	126
Bulldog Type Serrefines	127
Dieffenbach	227
Dietrich Bulldog	127
Double Clamps	123
Micro Serrefines	126
Mini Serrefines	127
S&T Micro	123
Schwartz Micro Serrefines	127
Titanium	126
Clock (Electronic Timer)	196
Cohan-Vannas Spring Scissors	24
Colibri Retractors	161-162
Combination Spatula and Probe	140
Combination Spatula and Spoon	140
Cover Glass Forceps	106
Crile Hemostats	119,220
Crile-Wood Needle Holders	153
Cross-Action Forceps	106
Curettes	69
Cutters	61,211
BeeBee Bone Scissors	64
Boehler Bone Cutter	65
Bone Nipper	62
Bone Pliers	67
Bone Scissors	64
Bone Shears	67
Bone Trimmers	60
Cartilage	60
Cleveland	66
Dumont	61
Liston Bone	66
Littauer Bone	64
Malleus Nipper	63
Skull Flap	65

D

DeBakey Forceps	111
Decapitation Scissors	54
Diamond Coated Forceps	94
Diamond Knives	74
Dieffenbach Clamp	227
Dietrich Bulldog Clamps	127
Double Micro Clamp Applying Forceps	124
Double Micro Clamps	123
Dowell Spring Scissors	27
Drill Accessories	
Burrs	187
Circular Saw	187

Mandrel	187
Trephines	187
Dumont	61,83-92,133,213

E

Ear Punches	171-172
Ear Tags	174
Episcleral Forceps	105
Eschenbach Magnifier	199-202
Clip-on LED light	200
Exclusive Line	
Forceps	93
Needle Holder	148
Rongeurs	55
Scissors	34

F

Feeding Needles	
Reusable	169
Single Use	170
Feilchenfeld Forceps	215
File Set	191
Fomon Retractor	160
Forceps	95-96
Adson	108
Adson (Student)	216
Adson DeBakey	109
Adson-Brown	109
Adson-Brown (Student)	216
Adson-Graefe	109
Allis Clamp Forceps	122
Allis Clamp Forceps (Student)	225
Balanced	93,112
Biemer Clip Applicator	125
Bishop-Harman	103
Bone	68
Bonn	100
Bonn Micro	100
Ceramic Coated	83,89
Circle	107
Components	92
Cover Glass	106
Cover Slip	87
Cross Action	106
DeBakey Round Handled	111
Diamond Coated	94
Double Micro Clamp Applying	124
Dumont	83-92,133
Dumont (Student)	213
Episcleral	105
Epoxy Coated	90-91
Feilchenfeld (Student)	215
Forceps Style Clip Applicator	125
Gerald	115
Gillies	114
Gillies (Student)	218
Gold Plated	93
Graefe	103-104
Insect Handling	107

Laminectomy	90
London	115
McIndoe (Student)	218
Micro Adson	108
Micro Adson (Student)	216
Micro-Blunted Tips	84
Mirror Finish	85,94-95
Moria Bonn	98
Moria Iris	97
Moria Paufique	98
Moria Suture Tying	101
Moria Ultra Fine	97
Mouse Handling	116
Narrow Pattern	110
O-Rings	175
Octagon	103
Organ Holding	114
Pierse Fixation	105
Plastic	106
Potts-Smith	116
Repair Kit	175
Replaceable Tips	95
Ring	107
Russian	114
Russian (Student)	218
S&T	99
S&T Micro Clamp Applying	124
S&T SuperGrip	99
S&T Suture Tying	101
S&T Vessel Cannulation	133
Self-Closing	96
Semken	111
Semken (Student)	218
Sliding Lock	87,105
Sorensen	112
Splinter (Student)	215
Standard Pattern	110
Standard Pattern (Student)	217
Student	214
Suture Tying	100-102
Taylor	116
Tissue	113
Titanium	115
Vessel Cannulation	133
Vessel Dilators	130
Vessel Dilators (Student)	227
Vial	102
Forceps Style Clip Applicator	125
Forceps with Replaceable Tips	95
Friedmann Rongeurs	59
Friedmann-Pearson Rongeurs	55-56

G

Galilean Loupes	199
Gavage Feeding Needles	169-170
Gelpi Retractor	165
GenoPunch	171
Gerald Forceps	115
Gillies Forceps	114,218
Gold Plated Forceps	93

Gold Wire Contacts	196
Goldstein Retractors	161
Graefe Forceps	103-104
Graefe Scissors	47
Grooved Director	139
Gross Anatomy Blade and Handle	80
Gross Anatomy Knives	72
Gross Anatomy Probe	139
Guthrie Retractor	160

H

Halsey Needle Holder	151,226
Halsted-Mosquito Hemostats	118,219
Hartmann Hemostats	121,219
Heavy Scissors	211
Heiss Retractor	165
Hemostats	117
Baby-Mixer	120
Crile	119
Crile (Student)	220
Halsted-Mosquito	118
Halsted-Mosquito (Student)	219
Hartmann	121
Hartmann (Student)	219
Kelly	119
Kelly (Student)	220
Kocher (Student)	222
Mosquito	118
Ochsner-Kocher (Student)	222
Pean (Student)	221
Providence-Hospital	120
Rochester-Pean (Student)	221
Ultra-fine	117
Hippocampal Dissecting Tool	144
Holders and Breakers	75
Hooks	136-137
Horizon™ Metal Ligation System	128
Hose Clamp	225
Hot Bead Sterilizer	178-179

I

Insect Handling Forceps	107
Insect Pins	147
Insert Pins	147
Instrument Care	
Double Tip Protectors	186
Forceps Repair Kit	175
Instrument Oil	175
Marking Tape	176
Sharpening Stones	175,191
Tip Protectors	186
Instrument Cases	
Aluminum (Storage)	184-185
Plastic (Storage)	185
Sterilization	182-183
Instrument Oil	175
Iris Scissors	35-41,206
Iris Spatula	142

K

Kalt Needle Holders	149
Kaye Scissors	47
Kelly Hemostats	119,220
Kocher Hemostats	222

L

LaGrange Scissors	44
Large Loops Scissors	47
Lempert Rongeurs	59
Lens Paper	203
Lexer-Baby Scissors	39
Ligation Aids	131
Ligation Systems	128
Lister	
Scissors	50,209
Sine Clamp	225
Liston Bone Cutter	66
Littauer Bone Cutter	64
London Forceps	115
Lorna Towel Clamp	122,224
Luer Rongeurs	57

M

Magnifiers / Loupes	195,197-202
Cleaning Kit	203
Headband	199
Malleus Nipper	63
Mandrel	187
Markers	173
Marking Tape	176
Mathieu Needle Holder	150
Mayo Scissors	53,209
Mayo-Hegar Needle Holder	152,226
Mayo-Noble Scissors	54
Mayo-Stillie Scissors	54
McIndoe Forceps	218
McPherson Forceps	101
Metzenbaum Baby Scissors	51,210
Metzenbaum Scissors	51-52,210
Michel Suture Clips & Applicators	157
Micro Clip Applicator	125
Micro Serrefines	126
Microsurgical Needles with Suture Thread	
Attached	154
Mini Serrefines	127
Minutien Pins	147
Moria	
Bonn Forceps	98
Bulldog Clamp	126
Forceps	97
Iris Scissors	37
Pascheff-Wolff Spring Scissors	28
Paufique Forceps	98
Retractors	162
Spoons	145
Spring Scissors	24
Suture Tying Forceps	101
Vannas-Wolff Spring Scissors	27
Vessel Clamp	126

ALPHABETICAL INDEX

Mosquito Hemostats Micro	118
Mouse Handling Forceps	116
Multipurpose Forceps	112

N

Narrow Pattern Forceps	110
Needle Holders	
Castroviejo	148,150
Crile-Wood	153
Halsey	151
Halsey (Student)	226
Kalt	149
Mathieu	150
Mayo-Hegar	152
Mayo-Hegar (Student)	226
Olsen-Hegar	152
Round Handled	148
Tungsten Carbide	150-153
Needles	
Etched Tungsten Micro Needles	147
Holders	146
Holders (Student)	226
Insect	147
Insert	147
Minutien	147
Suture Needles	155
Neuro Punches	190
Noyes Spring Scissors	29
Nylon Suture	155

O

O-Rings for Forceps	175
Obsidian Stone Age Scalpels	73
Ochsner-Kocher Hemostats	222
Octagon Forceps	103
Olsen-Hegar Needle Holder	152
Optical Cleaning Kit	203
Organ Holding Forceps	114

P

Pean Hemostats	221
Pearson Rongeurs	57
Pick	135
Pierse Fixation Forceps	105
Pin Holders	146,226
Plastic Forceps	106
Potts-Smith Forceps	116
Probes	137
Bonn Micro Probes	136
Double Pronged Pick	135
Providence-Hospital Hemostats	120
PTFE Feeding Needles	170

R

Repair Kit	175
Retraction System	167

Retractors	160-162,164,227
Agricola	162
Alm	163
Barraquer (Student)	227
Blair	160
Colibri	161-162
Fomon	160
Gelpi	165
Goldstein	161
Guthrie	160
Heiss	165
Senn-Miller (Student)	227
Weitlaner-Locktite	166
Wullstein	166
Reusable Feeding Needles	169
Ring Forceps	107
Rochester-Pean Hemostats	221
Rongeurs	
Baby-Beyer	58
Beyer	58
Friedmann	59
Friedmann-Pearson	55-56
Lempert	59
Luer	57
Pearson	57
Round Handled Needle Holders	148-149
Rulers	193
Russian Forceps	114,218

S

S&T	
Clamp Applying Forceps	124
Forceps	99
Micro Clamps	123
SuperGrip Forceps	99
Suture Tying Forceps	101
Vessel Cannulation Forceps	133
Vessel Dilators	130
Sample Corers	190
Sanvenero Scissors	206
Scalpels	
Breakable	75
Cataract Knife	70
Ceramic Blade Cutter	191
Ceramic Blades	74
Circle Knife	71
Diamond Knives	74
Disposable Safety Scalpels	80
Holders and Breakers	75
Micro	76
Micro Knives	71,76
Safety Scalpel Blade Cartridges	81
Scalpel Blade Remover	79
Scalpel Blades	77-78
Scalpel Handles	77-79,81
Scalpel Handles (Student)	212
Schwartz Micro Serrefines	127

Scissors	
Bone	64
Bone (Student)	211
Bonn	34-35
Bonn Artery	46
Bonn-Gawenda	34
Bonn-Strabismus	35
Decapitation	54
Dissector	45
Graefe	47
Heavy (Student)	211
Iris	35-41
Iris (Student)	206
Kaye	47
LaGrange	44
Large Loops	47
Lexer-Baby	39
Ligature	45
Lister	50
Lister (Student)	209
Mayo	53
Mayo (Student)	209
Mayo-Noble	54
Mayo-Stille	54
Metzenbaum	51-52
Metzenbaum (Student)	210
Metzenbaum Baby	51
Metzenbaum Baby (Student)	210
Micro	32
Moria Iris	37
Sanvenero (Student)	206
Shea	44
Spencer	45
Spencer (Student)	208
Stevens Tenotomy	43
Strabismus	42
Tissue Separating	46
Universal Scissors	192
Utility Scissors	192
Wagner	38
Wagner (Student)	208
Walton	43
Screwdriver	191
Semken Forceps	111,218
Senn-Miller Retractors	227
Sharpening Stones	175,191
Shea Scissors	44
Sichel Knife	70
Silicone Mat	181
Silk Sutures	155
Single Use Feeding Needles	170
Skin Staplers & Applicators	158-159
Sliding Lock Forceps	105
Spatula	141,143
Combination Probe and Spatula	140
Combination Spoon and Spatula	140
Spencer Ligature Scissors	45,208
Spinal Cord Hook	135
Splinter Forceps	215
Spoons	145

Spring Scissors	25,27,30-31
Biemer	33
Bone Cutting	63
Castroviejo	25-26
Clipper II	33
Cohan-Vannas	24
Dowell	27
Micro	32
Moria	24,27-28
Noyes	29
Pascheff-Wolff	28
Titanium	24
ToughCut	30
Trident II	31
Tungsten Carbide	29
Vannas	21-24,28,30
Vannas (Student)	206
Vannas-Tübingen	22
Vannas-Wolff	27
Westcott	28
Sterilization	
Containers	182-183
Disposable Wraps	180
Pouches	177
Tape	180
Stevens Tenotomy Scissors	43
Storage Cases	184-185
Strabismus Scissors	42
Surgical Scissors	48-50
Student	207
Tungsten Carbide	40-42,49,51,53
Suture Needles	154-155
Suture Tying Forceps	100-102
Suturing Principles and Techniques in Laboratory Animals	156

T

Taylor Forceps	116
Timer (Electronic)	196
Tip Protectors	186
Tissue Forceps	113
Tissue Separating Scissors	46
Titanium Forceps	115
Titanium Micro Point, Y-Hook, and Spatula	138
Tohoku Towel Clamp	223
Towel Clamps	
Backhaus	121
Backhaus (Student)	223
Lorna	122
Lorna (Student)	224
Tohoku (Student)	223
Travel Case for instruments	186
Trephines	187
Trident II Spring Scissors	31

V

Vannas Spring Scissors	21-24,28,30,206
Vannas-Tübingen Spring Scissors	22
Vascular Occluders	129
Vessel Cannulation Forceps	133
Vessel Dilating Probe	139
Vessel Dilators	130,227
Vial Forceps	102
Von Graefe Knife	70
Wagner Scissors	38,208
Walton Scissors	43
Weitlaner-Locktite Retractor	166
Westcott Spring Scissors	28
Wraps	180
Wullstein Retractor	166

FINE SCIENCE TOOLS AROUND THE WORLD

SHIPPING GLOBALLY SINCE 1974

★ Corporate Offices

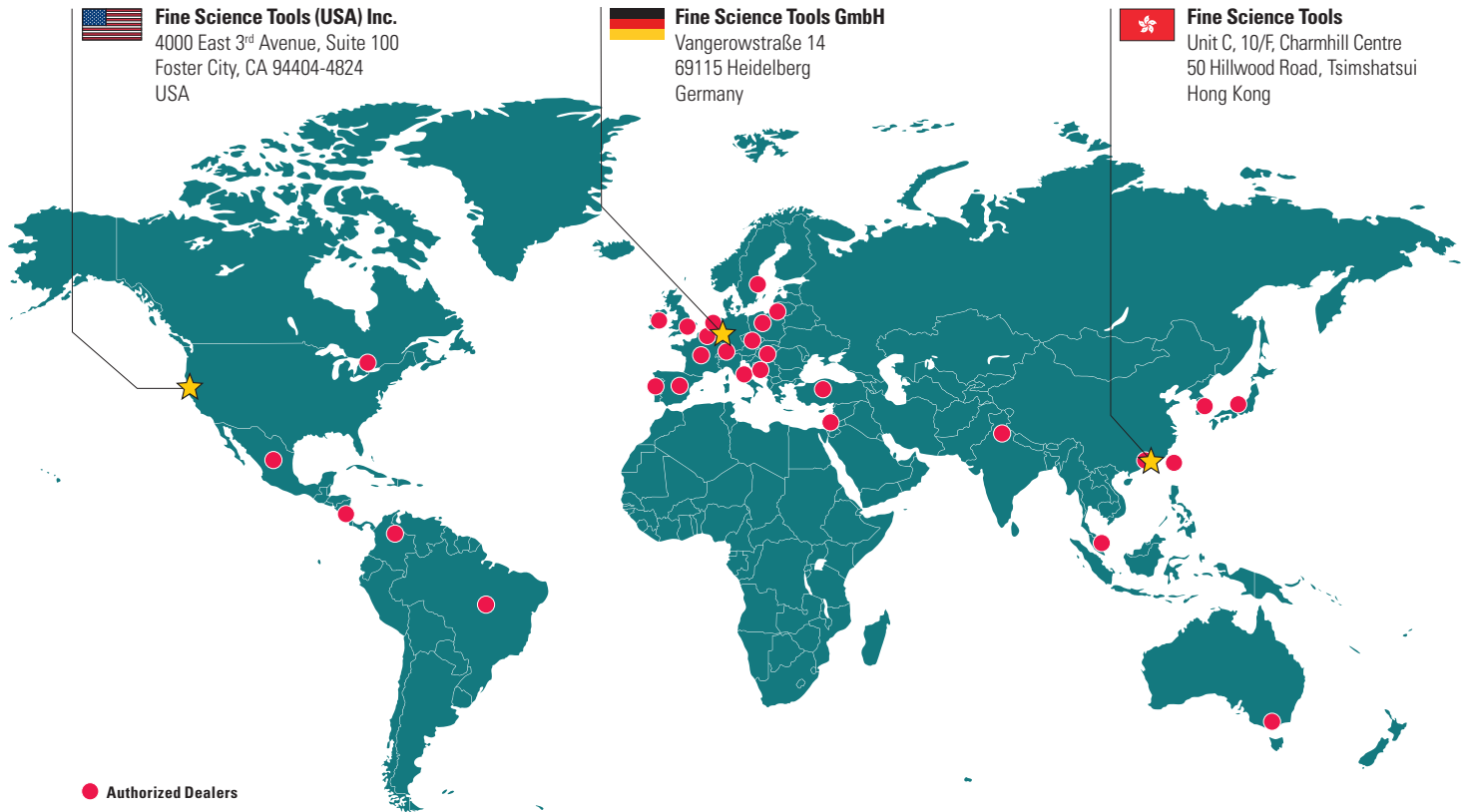

Fine Science Tools (USA) Inc.
4000 East 3rd Avenue, Suite 100
Foster City, CA 94404-4824
USA

Fine Science Tools GmbH
Vangerowstraße 14
69115 Heidelberg
Germany

Fine Science Tools
Unit C, 10/F, Charmhill Centre
50 Hillwood Road, Tsimshatsui
Hong Kong

● Authorized Dealers

- | | | | | |
|---|---|---|---|---|
| Australia
Cleanaway Daniels
Laboratory Products. | Belgium
Bio-Connect B.V. | Brazil
Lab Research do Brasil Ltda. | Canada
Cedarlane Labs | China
RWD Life Science Co., Ltd
Hunan Yuanxiang Bio. Co., Ltd.
Shenzhen Zeren Tech. Co., Ltd. |
| Colombia
Intrage Internacional S.A.S | Costa Rica
PRMC Precision and Medical
Components Ltda. | Croatia
AnimaLab | Czech Republic
AnimaLab | Israel
NBT
Bar-Naor Ltd. |
| France
PHYMEP S.A.R.L. | Hungary
AnimaLab | India
Samitek Instruments | Ireland
Brennan & Co - SVS | Netherlands
Bio-Connect B.V. |
| Italy
2Biological Instruments S.N.C.
Unimed Scientifica S.N.C. | Japan
Muromachi Kikai Co., Ltd. | Latvia
AnimaLab | Mexico
Cientifica Senna
LATAM Scientific | Spain
Bionic Ibérica SA
Cibertec SA
Sodispan Research SL
GENOCHEM WORLD SL. |
| Poland
AnimaLab | Portugal
Ultragene | Singapore
Precision Technologies PTE Ltd. | South Korea
IWOOD SCIENTIFIC CORPORATION
SciTech
Sungwoo Lifescience
Kim & Friends, Inc. | |
| Sweden
AgnTho's AB | Switzerland
Aichele Medico AG | Taiwan
Proserv Instruments Co., Ltd. | | |
| Türkiye
Radon Medical, Ltd. | United Kingdom
Interfocus Ltd. | | | |

All of our European suppliers are ISO 9001 certified. All FST surgical instruments are made from the finest German stainless steel alloys (unless otherwise noted) and manufactured by skilled European craftsmen. Most surgical instruments are shown actual size. As these instruments are handcrafted, dimensions may vary slightly from those stated in this catalog.

The information in this catalog is accurate to the best of our knowledge. Designs, styles and dimensions depicted in this catalog are subject to change without notice. All recommendations or suggestions are made without guarantee, and we disclaim any liability incurred in connection with any recommendation. With the purchase of any product from this catalog the user assumes all risks and liabilities whatsoever in the use of such products. Neither seller nor manufacturer shall be liable in tort or contract for any loss or damage (direct, incidental, or consequential) arising out of the use, misuse, or inability to use such product.

FST is a registered trademark of Fine Science Tools Inc. Fine Science Tools, ToughCut, CeraCut, and Fine Surgical Instruments for Research are trademarks of Fine Science Tools Inc. FST, ToughCut, and CeraCut are registered trademarks of Fine Science Tools (USA) Inc. Fine Science Tools and Fine Surgical Instruments for Research are trademarks of Fine Science Tools (USA) Inc. Fine Science Tools and FST are registered trademarks of Fine Science Tools GmbH.

© COPYRIGHT 2025 The text, photos and drawings contained in this catalog are proprietary to Fine Science Tools Inc. and may only be copied, duplicated or otherwise reproduced with the written consent of Fine Science Tools Inc.



Scissors, Bone Instruments,
Knives & Scalpels
pages 21 – 81



Forceps/Tweezers, Hemostats
& Vascular Instruments
pages 83 – 133



Probes, Needle Holders, Thread,
Retractors & Clamps
pages 135 – 167



Surgical & Laboratory
Accessories
pages 169 – 203

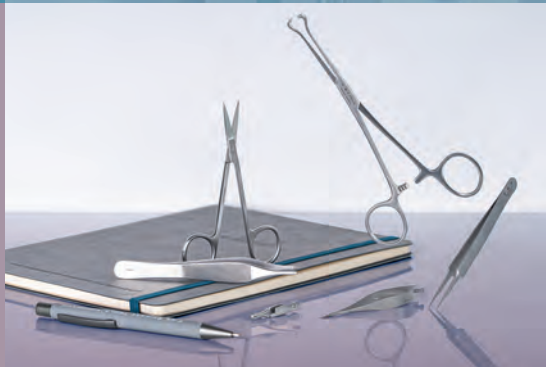

Student Quality Instruments
pages 205 – 227



Fine Science Tools (USA) Inc.

4000 East 3rd Avenue, Suite 100
Foster City, CA 94404-4824
USA

Telephone +1 800-521-2109 / +1 650-349-1636

Fax +1 800-523-2109 / +1 650-349-3729

E-Mail america@finescience.com

Web finescience.com



Fine Science Tools GmbH

Vangerowstraße 14
69115 Heidelberg
Germany

Telephone +49 62 21 - 90 50 50

Fax +49 62 21 - 90 50 590

E-Mail europa@finescience.com

Web finescience.com



Fine Science Tools

Unit C, 10/F, Charmhill Centre
50 Hillwood Road, Tsimshatsui
Hong Kong

Telephone +852 653 292 29

E-Mail asia@finescience.com

Web finescience.com